

HF3503

DELAYING RELAY



Typical Applications

Heating control, Start control, Fan Control

Features

- Use MCU control circuit to ensure stable performance and high precision
- Solid base design, stable structure
- Surface mounting technology, advanced craftwork
- Ingress protection: IP50

ELECTRICAL PARAMETER

Type	Nominal Voltage VDC	Operating Voltage VDC	Delay Time s	Rated Load A	Electrical endurance OPS	Voltage drop mV/5A max.
HF3503/12-G40A2	12	9 to 16	2.0 ± 0.5	40	1 x 10 ⁵	150
HF3503/12-L15B9-B	12	9 to 16	9.0 ± 2.0	15	1 x 10 ⁵	150
HF3503/12-G15B480	12	9 to 16	480 ± 60	15	1 x 10 ⁵	150
HF3503/24-G20A5	24	18 to 32	5.0 ± 1.0	20	1 x 10 ⁵	150
HF3503/12-G15B600	12	9 to 16	600 ± 60	15	1 x 10 ⁵	150
HF3503/24-G15A8-B	24	18 to 32	8.0 ± 1.5	15	1 x 10 ⁵	150
HF3503/12-G15A8-B	12	9 to 16	8.0 ± 1.5	15	1 x 10 ⁵	150

When demand of time delay is different from above, please contact Hongfa for more technology support.

OTHER PARAMETERS

Ambient temperature	-40°C to 85°C	
Vibration resistance	Sine	10Hz to 200Hz 49m/s ²
	Random	10Hz to 1000Hz 19.6m/s ²
Shock resistance	196m/s ²	
Weight	Approx. 35g	
Mechanical data	Cover retention: 160N min.	
	Terminal retention: 100N min.	

ORDERING INFORMATION

Type	HF3503 /	12	-G	40	A	2	-B	(XXX)
	Suffix (A-Z) is for specific extending application							
Nominal voltage	12: 12VDC 24: 24VDC							
Trigger level	G: High electric level start up L: Low electric level start up							
Electrical current specification	15: 15A 20: 20A 40: 40A							
Delayed mode	A: On delay B: Off delay							
Delayed time	2: 2s 10: 10s							
Packing style	B: With bracket Nil: Without bracket							
Special code ¹⁾	XXX: Customer special requirement Nil: Standard							

Notes: 1) The customer special requirement express as special code after evaluating by Hongfa.



HONGFA RELAY

ISO9001, ISO/TS16949, ISO14001, OHSAS18001, IECQ QC 080000 CERTIFIED

2015 Rev. 1.00

OUTLINE DIMENSIONS, WIRING DIAGRAM, LOGIC DIAGRAM

Unit: mm

Outline Dimensions

HF3503/□□-□□□□□(XXX)

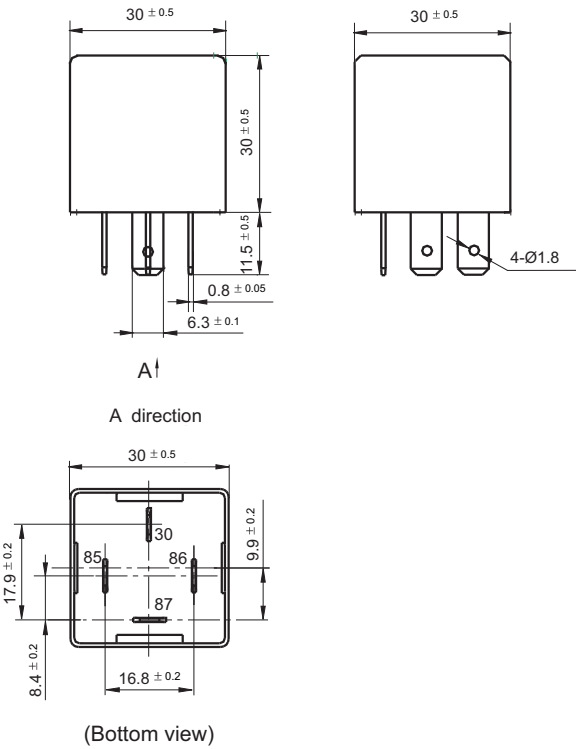

HF3503/□□-□□□□□-B(XXX)

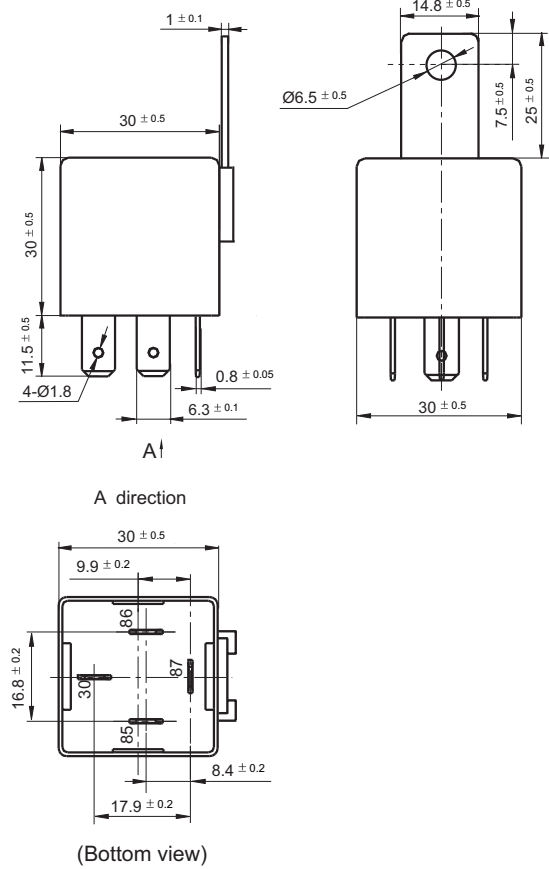

OUTLINE DIMENSIONS, WIRING DIAGRAM, LOGIC DIAGRAM

Unit: mm

HF3503/12-G40A2(XXX)

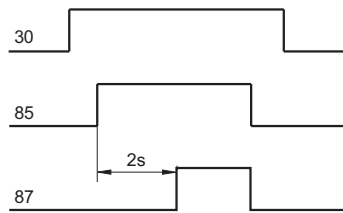
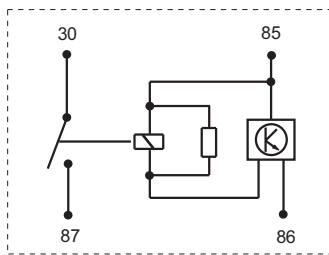

1) The terminal 30 is connected with positive electrode of power supply, terminal 87 is connected with load, the terminal 86 is connected with nature, the terminal 85 is connected with control signal. As shown in logic diagram, the terminal 30 and 87 will be connected when terminal 85 received a 12V start-up signal and delayed $2s \pm 0.5s$.

HF3503/12-L15B9-B(XXX)

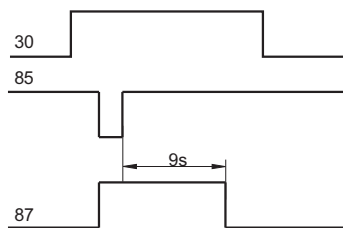
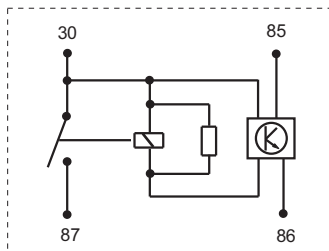

1) The terminal 30 is connected with positive electrode of power supply, terminal 87 is connected with load, the terminal 86 is connected with nature, the terminal 85 is connected with control signal. As shown in logic diagram, the terminal 30 and 87 will be connected when terminal 85 received a low level start-up signal, the terminal 30 and 87 will be opened when 85 terminal start-up signal disappeared and delayed $9s \pm 2s$.

OUTLINE DIMENSIONS, WIRING DIAGRAM, LOGIC DIAGRAM

Wiring Diagram

HF3503/12-G15B480(XXX)

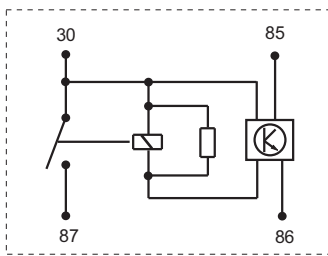

Logic Diagram

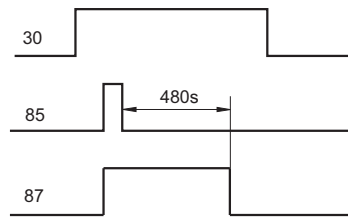

- 1) The terminal 30 is connected with positive electrode of power supply, terminal 87 is connected with load, the terminal 86 is connected with nature, the terminal 85 is connected with control signal. As shown in logic diagram, the terminal 87 and 30 will be connected when terminal 85 received a 12V start-up signal, the terminal 87 and 30 will be opened when terminal 85 start-up signal disappeared and delayed 480s ± 60s.

HF3503/24-G20A5(XXX)

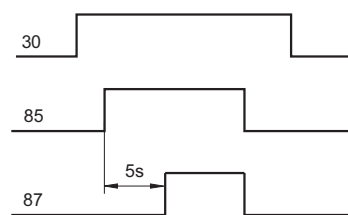
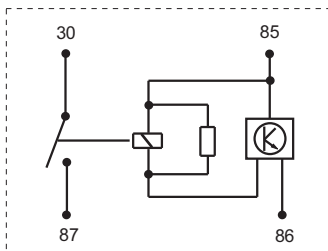

- 1) The terminal 30 is connected with positive electrode of power supply, terminal 87 is connected with load, the terminal 86 is connected with nature, the terminal 85 is connected with control signal. As shown in logic diagram, the terminal 30 and 87 will be connected when terminal 85 received a 24V start-up signal and delayed 5s ± 1s.

HF3503/12-G15B600(XXX)

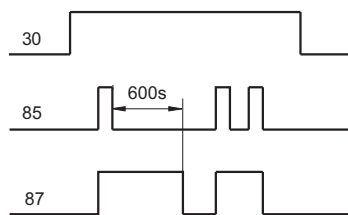
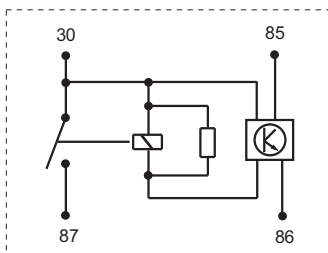

- 1) The terminal 30 is connected with positive electrode of power supply, terminal 87 is connected with load, the terminal 86 is connected with nature, the terminal 85 is connected with control signal. As shown in logic diagram, the terminal 87 and 30 will be connected when terminal 85 received a 12V start-up signal, the terminal 87 and 30 will be opened when terminal 85 start-up signal disappeared and delayed 600s ± 60s. During the delay period after connection, the terminal 87 and 30 will be opened when terminal 85 receive start-up signal.

HF3503/24-G15A8-B(XXX)
HF3503/12-G15A8-B(XXX)

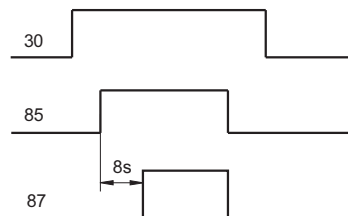
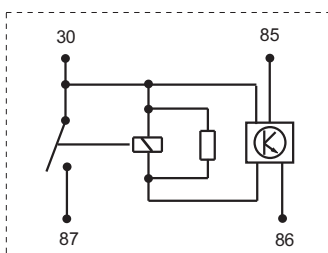

- 1) The terminal 30 is connected with positive electrode of power supply, terminal 87 is connected with load, the terminal 86 is connected with nature, the terminal 85 is connected with control signal. As shown in logic diagram, the terminal 87 and 30 will be connected when terminal 85 received a start-up signal and delayed for 8s ± 1.5s.

Disclaimer

The specification is for reference only. See to "Terminology and Guidelines" for more information. Specifications subject to change without notice. In case there is specific criterion (such as mission profile, technical specification, PPAP etc.) checked and agreed by and between customer and Hongfa, this specific criterion should be taken as standard regarding any requirement on Hongfa product. We could not evaluate all the performance and all the parameters for every possible application. Thus the user should be in a right position to choose the suitable product for their own application. If there is any query, please contact Hongfa for the technical service. However, it is the user's responsibility to determine which product should be used only.

© Xiamen Hongfa Electroacoustic Co., Ltd. All rights of Hongfa are reserved.