

# HF115F-A

# MINIATURE HIGH POWER RELAY



File No.:E134517



File No.:116934



File No.:CQC1702176311

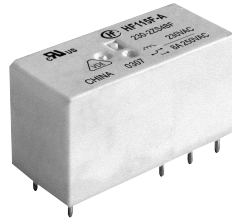

## Features

- AC voltage coil type
- 16A switching capability
- 1 & 2 pole configurations
- 5kV dielectric strength (between coil and contacts)
- Low height: 15.7 mm
- Creepage distance: 10mm
- Meeting VDE 0700, 0631 reinforce insulation
- Product in accordance to IEC 60335-1 available
- Sockets available
- Plastic sealed and flux proofed types available
- UL insulation system: Class F
- Environmental friendly product (RoHS compliant)
- Outline Dimensions: 29.0mm x 12.7mm x 15.7mm

## CONTACT DATA

Contact arrangement	1A, 1B, 1C	2A, 2B, 2C
Contact resistance <sup>1)</sup>	100mΩ max.(at 1A 6VDC)	
Contact material	See ordering info.	
Contact rating (Res. load)	12A/16A 250VAC	8A 250VAC
Max. switching voltage	440VAC / 300VDC	
Max. switching current	12A / 16A	8A
Max. switching power	3000VA / 4000VA	2000VA
Mechanical endurance	1 x 10 <sup>6</sup> ops	
Electrical endurance	1H3B type: 5 x 10 <sup>4</sup> ops (16A 250VAC, Resistive load, Room temp., 1s on 9s off) 2H4B type: 5 x 10 <sup>4</sup> ops (8A 250VAC, Resistive load, Room temp., 1s on 9s off)	

Notes: 1) The data shown above are initial values.

## CHARACTERISTICS

Insulation resistance	1000MΩ (at 500VDC)	
Dielectric strength	Between coil & contacts	5000VAC 1min
	Between open contacts	1000VAC 1min
	Between contact sets	2500VAC 1min
Temperature rise (at nomi. volt.)	85K max.	
Shock resistance *	Functional	98m/s <sup>2</sup>
	Destructive	980m/s <sup>2</sup>
Vibration resistance *	10Hz to150Hz 10g/5g	
Humidity	5% to 85% RH	
Ambient temperature	-40°C to 70°C	
Termination	PCB	
Unit weight	Approx. 13.5g	
Construction	Plastic sealed, Flux proofed	

Notes: 1) The data shown above are initial values.

2) \* Index is not that of relay length direction.

## COIL

Coil power	Approx. 0.75VA
------------	----------------

## COIL DATA (at 50Hz)

at 23°C

Nominal Voltage VAC	Pick-up Voltage VAC max. <sup>1)</sup>	Drop-out Voltage VAC min. <sup>1)</sup>	Coil Current mA	Coil DC Resistance Ω
24	18.00	3.60	31.6	350 x (1±10%)
115	86.30	17.30	6.6	8100 x (1±15%)
230	172.50	34.50	3.2	32500 x (1±15%)

Notes: 1) The data shown above are initial values.

## SAFETY APPROVAL RATINGS

UL/CUL	12A 250VAC
	16A 250VAC
	8A 250VAC
VDE (AgNi, AgNi+Au)	12A 250VAC at 70°C
	16A 250VAC at 70°C
	8A 250VAC at 70°C
VDE (AgSnO <sub>2</sub> , AgSnO <sub>2</sub> +Au)	12A 250VAC at 70°C
	8A 250VAC at 70°C

Notes: 1) All values unspecified are at room temperature.

2) Only typical loads are listed above. Other load specifications can be available upon request.



HONGFA RELAY

ISO9001, ISO/TS16949, ISO14001, OHSAS18001, IECQ QC 080000 CERTIFIED

2018 Rev. 1.00

## ORDERING INFORMATION

Type	HF115F-A / 024 -1H S 1 A F (XXX)						
Coil voltage	24, 115, 230VAC						
Contact arrangement	1H: 1 Form A 1D: 1 Form B 1Z: 1 Form C 2H: 2 Form A 2D: 2 Form B 2Z: 2 Form C						
Construction <sup>1) 2)</sup>	S: Plastic sealed Nil: Flux proofed						
Version	1: 3.5mm 1 pole 12A 2: 5.0mm 1 pole 12A 3: 5.0mm 1 pole 16A 4: 5.0mm 2 pole 8A						
Contact material <sup>3)</sup>	A: AgSnO <sub>2</sub> B: AgNi Nil: AgCdO G: AgCdO+Au plated AG: AgSnO <sub>2</sub> +Au plated BG: AgNi+Au plated						
Insulation standard	F: Class F						
Special code <sup>4)</sup>	XXX: Customer special requirement Nil: Standard						

- Notes: 1) We recommend flux proofed types for a clean environment (free from contaminations like H<sub>2</sub>S, SO<sub>2</sub>, NO<sub>2</sub>, dust, etc.). We suggest to choose plastic sealed types and validate it in real application for an unclear environment (with contaminations like H<sub>2</sub>S, SO<sub>2</sub>, NO<sub>2</sub>, dust, etc.).
- 2) Contact is recommended for suitable condition and specifications if water cleaning or surface process is involved in assembling relays on PCB.
- 3) For gold plated type, the min. switching current and min. switching voltage is 10mA 5VDC.
- 4) The customer special requirement express as special code after evaluating by Hongfa. e.g.(335) stands for product in accordance to IEC 60335-1 (GWT).

## OUTLINE DIMENSIONS, WIRING DIAGRAM AND PC BOARD LAYOUT

Unit: mm

### Outline Dimensions

3.5mm Pinning (HF115F-A/ - - -1- ) 5mm Pinning (HF115F-A/ - - -2/3/4- )

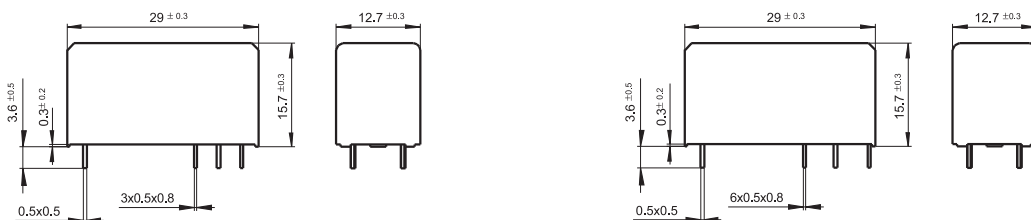

### PCB Layout (Bottom view)

#### 3.5mm 1Pole 12A

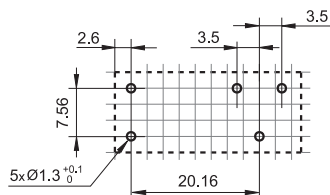

#### 5mm 1Pole 12A

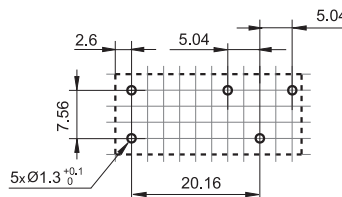

#### 5mm 1Pole 16A

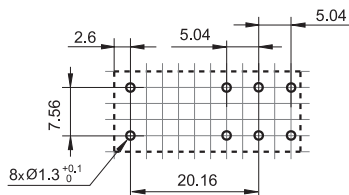

#### 5mm 2Pole 8A

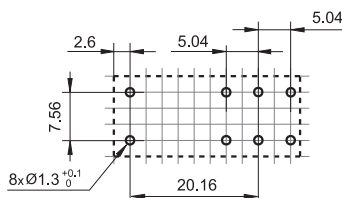

- Remark: 1) In case of no tolerance shown in outline dimension: outline dimension  $\leq 1$ mm, tolerance should be  $\pm 0.2$ mm; outline dimension  $> 1$ mm and  $\leq 5$ mm, tolerance should be  $\pm 0.3$ mm; outline dimension  $> 5$ mm, tolerance should be  $\pm 0.4$ mm.
- 2) The tolerance without indicating for PCB layout is always  $\pm 0.1$ mm.
- 3) The width of the gridding is 2.52mm.

Wiring Diagram (Bottom view)

HF115F-A/ - - -1/2- , 3.5/5mm Pinning, 1 Pole, 12A



1 Form A



1 Form B

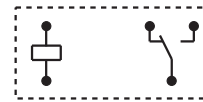

1 Form C

HF115F-A/ - - -3- , 5mm Pinning, 1 Pole, 16A



1 Form A

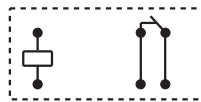

1 Form B

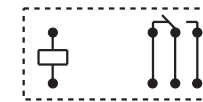

1 Form C

HF115F-A/ - - -4- , 5mm Pinning, 2 Pole, 8A



2 Form A

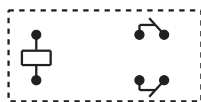

2 Form B

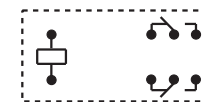

2 Form C

**CHARACTERISTIC CURVES**

MAXIMUM SWITCHING POWER

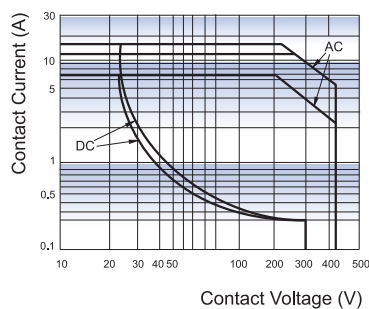

ENDURANCE CURVE

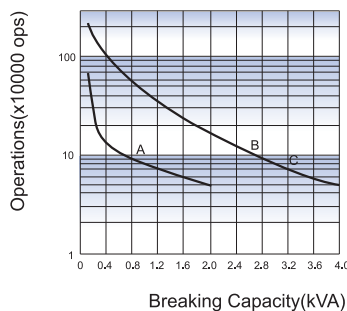

COIL OPERATING RANGE (AC) \*

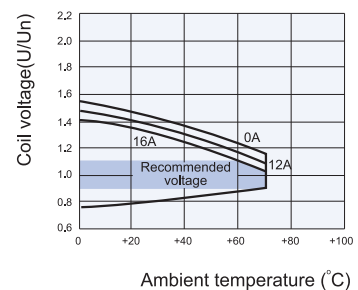

**Notes:**

- 1) Curve A: 2H4B type  
Curve B: 1H1B(or 1H2B) type  
Curve C: 1H3B type
- 2) Test conditions:  
NO, Resistive load, 250VAC  
Flux proofed, Room temp., 1s on 9s off.

**Notes:**

\* The use of a relay with an energising voltage other than the rated coil voltage may lead to reduced electrical life. An energising voltage over the abver range may damage the insulation of relay coil.

# Relay Sockets



## Features



- The insulation resistance is 1000MΩ
- Three mounting types are available: PCB, screw mounting and DIN rail mounting
- With finger protection device
- Many kinds of plug-in modules are available with the function of energizing indication and wiring protection
- Environmental friendly product (RoHS compliant)

## CHARACTERISTICS

Type	Nominal Voltage	Nominal Current	Ambient Temperature	Dielectric Strength S.	Screw Torque	Wire Strip Length
14FF-2Z-A1	250VAC	10A	-40 °C to 70°C	5000VAC	—	—
14FF-2Z-C2	250VAC	10A	-40 °C to 70°C	5000VAC	0.6N·m	7mm
14FF-2Z-C3	250VAC	10A	-40 °C to 70°C	5000VAC	0.6N·m	7mm
14FF-2Z-C4	250VAC	10A	-40 °C to 70°C	5000VAC	—	9mm

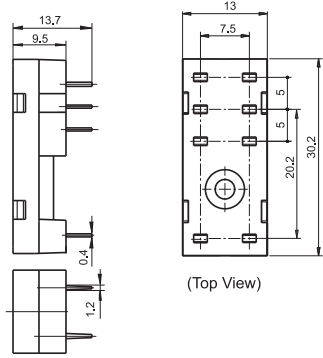
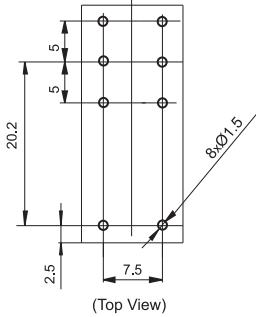

## OUTLINE DIMENSIONS, WIRING DIAGRAM AND PC BOARD LAYOUT

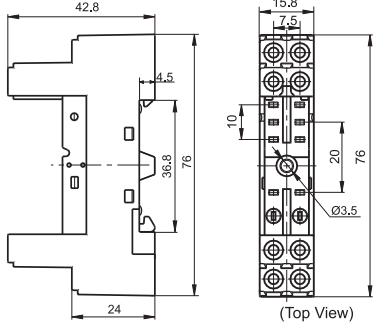
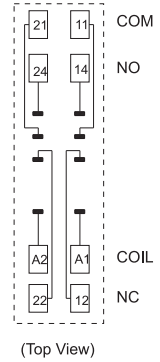
Unit: mm

Socket	Outline Dimensions	Wiring Diagram / PCB Layout	Components Available
<p>14FF-2Z-A1</p>  <p>PCB terminal, PCB or Screw mounting Applicable for HF115F/XXX-1XX3XXX HF115F/XXX-1XX4XXX When it is HF115F/XXX-1XX3XXX, two pole of socket load must connect in parallel.</p>	 <p>(Top View)</p>	 <p>(Top View)</p>	<p>metallic retainer 14FF-H1</p> <p>remarks:the dielectric strength can reach 1500VAC that sockets mounted 14FF-H1</p>
<p>14FF-2Z-C2</p>  <p>Screw Terminal, DIN rail or Screw mounting, With finger protection device Applicable for HF115F/XXX-1XX3XXX HF115F/XXX-1XX4XXX When it is HF115F/XXX-1XX3XXX, "21"- "11", "24"- "14", "22"- "12" of socket must connect in parallel.</p>	 <p>(Top View)</p>	 <p>(Top View)</p>	<p>plastic retainer 14FF-H4</p> <p>marker 14FF-M1</p> <p>plug-in module HF4A to HF4U*</p>

# OUTLINE DIMENSIONS, WIRING DIAGRAM AND PC BOARD LAYOUT

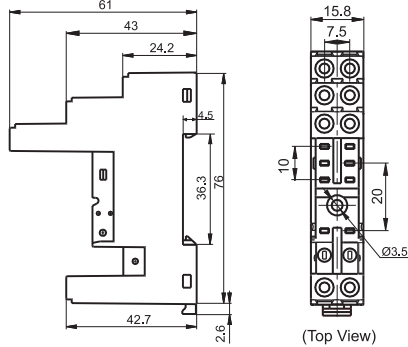
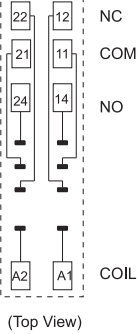
Unit: mm

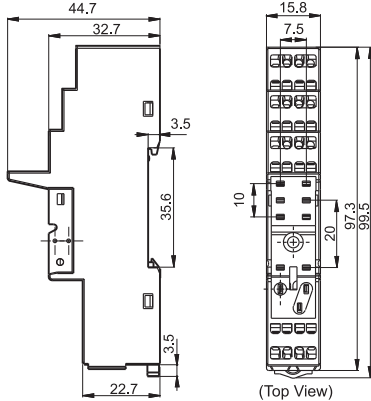
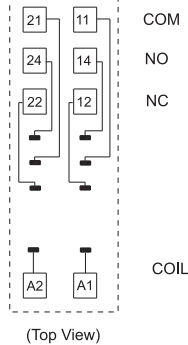
Socket	Outline Dimensions	Wiring Diagram / PCB Layout	Components Available
<p><b>14FF-2Z-C3</b></p>  <p>Screw Terminal, DIN rail or Screw mounting, With finger protection device Applicable for HF115F/ XXX-1XX3XXX HF115F/ XXX-1XX4XXX When it is HF115F/XXX-1XX3XXX, "21"-11", "24"-14", "22"-12" of socket must connect in parallel.</p>	 <p>(Top View)</p>	 <p>(Top View)</p>	<p>plastic retainer 14FF-H4</p> <p>marker 14FF-M1</p> <p>plug-in module HFAA to HFHU*</p>
<p><b>14FF-2Z-C4</b></p>  <p>Spring-loaded terminal DIN rail mounting With finger protection device Applicable for HF115F/ XXX-1XX3XXX HF115F/ XXX-1XX4XXX When it is HF115F/XXX-1XX3XXX, "21"-11", "24"-14", "22"-12" of socket must connect in parallel.</p>	 <p>(Top View)</p>	 <p>(Top View)</p>	<p>plastic retainer 14FF-H4</p> <p>marker 14FF-M1</p> <p>plug-in module HFAA to HFHU*</p>

**Notes:** \* Please refer to the product datasheet if plug-in module is required.

# DIMENSION OF RELATED COMPONENT (AVAILABLE)

Unit: mm

## Retainer

14FF-H1 (Metallic retainer)

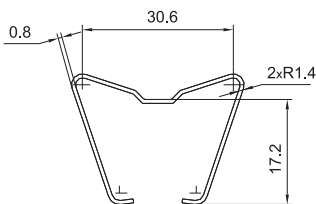

14FF-H4 (Plastic retainer)

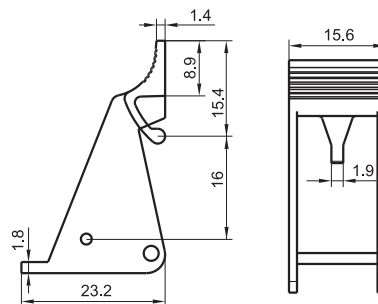

Marker

14FF-M1

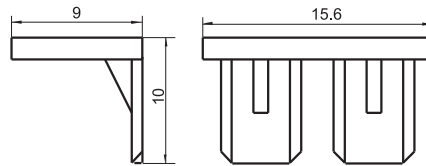

**Things to be noticed when selecting sockets:**

1. Please choose suitable relay socket according to the actual mounting environment, relay contact poles and terminal layout. If there is any query on selection, please contact Hongfa for the technical service.
2. Socket which can be mounted with markers is furnished with a marker; as for other related components, they should be selected separately. Please do give clear indication of the types of relay sockets and related components you choose while placing order.
3. The above is only an example of typical socket and related component type which is suitable to HF115F-A relay. If you have any special requirements, please contact us.
4. Main outline dimension, outline dimension >50mm, tolerance should be  $\pm 1\text{mm}$ ;  $20\text{mm} < \text{outline dimension} \leq 50\text{mm}$ , tolerance should be  $\pm 0.5\text{mm}$ ;  $5\text{mm} < \text{outline dimension} \leq 20\text{mm}$ , tolerance should be  $\pm 0.4\text{mm}$ ; outline dimension  $\leq 5\text{mm}$ , tolerance should be  $\pm 0.3\text{mm}$ .
5. DIN rail mounting: recommend to use standard rail  $35 \times 7.5 \times 1\text{mm}$ ,  $35 \times 15 \times 1\text{mm}$ .

**Disclaimer**

The specification is for reference only. See to "Terminology and Guidelines" for more information. Specifications subject to change without notice. We could not evaluate all the performance and all the parameters for every possible application. Thus the user should be in a right position to choose the suitable product for their own application. If there is any query, please contact Hongfa for the technical service. However, it is the user's responsibility to determine which product should be used only.

© Xiamen Hongfa Electroacoustic Co., Ltd. All rights of Hongfa are reserved.