

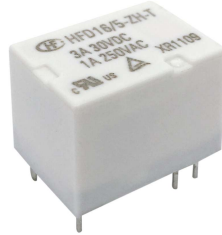

File No.: E133481



File No.: R50075326



Features

- 8A switching capability
- UL insulation system: Class F available
- Plastic sealed and flux proofed types available
- Standard PCB layout
- Product in accordance to IEC 60335-1 available

CONTACT DATA

Contact arrangement	1C
Contact resistance ¹⁾	100mΩ max. (AgNi gold-plated specifications: 0.1A 30mVDC, AgNi non gold-plated specifications and AgSnO ₂ :1A 30mVDC)
Contact material	AgNi, AgSnO ₂
Contact rating (Res. load)	3A 30VDC 1A 125VAC
Max. switching voltage	250VAC / 220VDC
Max. switching current	8A(30VDC)
Max. switching power	750VA / 90W
Min. applicable load	5V 1mA(Suitable for AgNi gold-plated specifications)
Mechanical endurance	1 x 10 ⁷ OPS
Electrical endurance	1X10 ⁶ OPS(NO:AgNi, 85°C, 1s on 9s off, 3A30VDC) 1X10 ⁶ OPS(NO:AgNi, 85°C, 1s on 9s off,5A125VAC)

Notes: 1) The data shown above are initial values.
2)Min. applicable load is reference value. Please perform the confirmation test with the actual load before production since reference value may change according to switching frequencies, environmental conditions and expected contact resistance and reliability.

CHARACTERISTICS

Insulation resistance	1000MΩ (at 500VDC)	
Dielectric strength	between coil & contacts	1100VAC 1min
	between open contacts	750VAC 1min
Operate time (at rated voltage.)	5ms max.	
Release time (at rated voltage.)	5ms max.	
Shock resistance	Functional	98m/s ²
	Destructive	980m/s ²
Vibration resistance	Functional	10Hz to 55Hz 1.5mm DA
	Destructive	10Hz to 55Hz 3.3mm DA
Surge withstand voltage between open contacts(10/160 μ s)	1000V(FCC part 68)	
between coil & contacts(2/10 μ s)	1500V(Telecordia)	
Humidity	5% to 85% RH	
Ambient temperature	-40°C to 85°C	
Termination	PCB (DIP)	
Unit weight	Approx. 4g	
Construction	Plastic sealed, Flux proofed	

Notes: 1) The data shown above are initial values.
2) UL insulation system: Class F.



HONGFA RELAY

ISO9001, ISO/TS16949, ISO14001, OHSAS18001, IECQ QC 080000 CERTIFIED

2019 Rev. 1.01

COIL

Coil power H type: 200mW;

COIL DATA

at 23°C

Nominal Voltage VDC	Pick-up Voltage VDC ¹⁾ max.	Drop-out Voltage VDC ¹⁾ min.	Max. Voltage ²⁾ VDC	Coil Resistance x (1±10%) Ω
				H
2.4	≤1.80	≥0.24	3.12	28.8
3	≤2.25	≥0.3	3.90	45.0
4.5	≤3.38	≥0.45	5.85	101.3
5	≤3.75	≥0.5	6.50	120
6	≤4.5	≥0.6	6.63	180
9	≤6.75	≥0.9	11.7	400
12	≤9.00	≥1.2	15.6	700
18	≤13.5	≥1.8	23.4	1620
24	≤18.0	≥2.4	31.2	2800

Notes: 1) The data shown above are initial values.
2) Maximum voltage refers to the maximum voltage which relay coil could endure in a short period of time.

SAFETY APPROVAL RATINGS

UL/CUL	AgNi	5A 125VAC 1A 125VAC, 85°C 3A 30VDC, 85°C
	AgSnO ₂	1A 125VAC, 85°C 3A 30VDC, 85°C TV-1 125VAC
TÜV	AgNi	1A 250VAC 1A 125VAC, 85°C 3A 30VAC, 85°C 3A 250VAC
	AgSnO ₂	1A 250VAC, 85°C 3A 30VAC, 85°C 1(1) 250VAC 3A 250VAC

Notes: 1) All values unspecified are at room temperature.
2) Only typical loads are listed above. Other load specifications can be available upon request.

ORDERING INFORMATION

Type	HFD16/ 24 -Z F H -3 N (XXX)						
Coil voltage	2.4, 3, 4.5, 5, 6, 9, 12, 18, 24 VDC						
Contact arrangement	Z:1 Form C						
Construction	F: Flux proofed			Nil: Plastic sealed			
Coil power	H: High sensitive (200mW)						
Contact material	3: AgNi			T: AgSnO ₂			
Contact plating	Nil: gold plated ³⁾			N: No gold plated			
Special code ¹⁾	XXX: Customer special requirement			Nil: Standard			

Notes: 1) The customer special requirement express as special code after evaluating by Hongfa.

2) The standard size of this product tube package is 409mm.

3) Only suitable for AgNi contact specifications .

OUTLINE DIMENSIONS, WIRING DIAGRAM AND PC BOARD LAYOUT

Unit: mm

Outline Dimensions

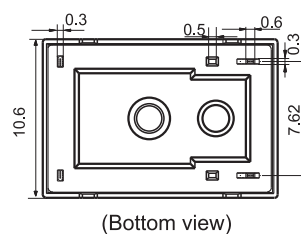
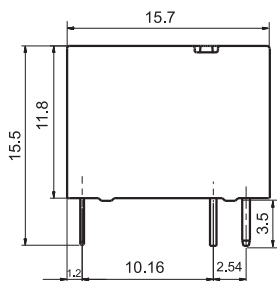

Wiring Diagram
(Bottom view)

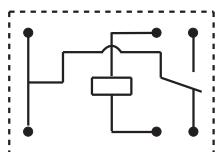

PCB Layout
(Bottom view)

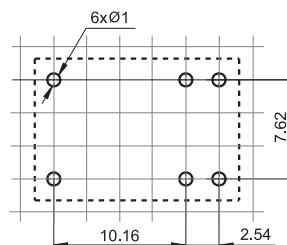

Remark: 1) In case of no tolerance shown in outline dimension: outline dimension ≤ 1 mm, tolerance should be ± 0.2 mm; outline dimension > 1 mm and ≤ 5 mm, tolerance should be ± 0.3 mm; outline dimension > 5 mm, tolerance should be ± 0.4 mm.

2) The tolerance without indicating for PCB layout is always ± 0.1 mm.

3) The width of the gridding is 2.54mm.

CHARACTERISTIC CURVES

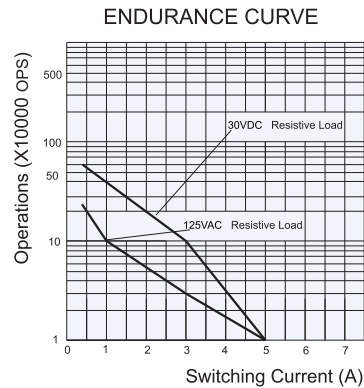
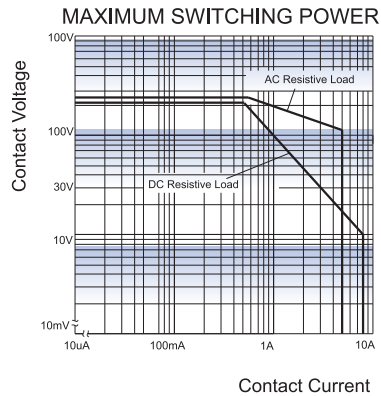

Test conditions:

NO:AgNi, Resistive load, 85°C, 1s on 9s off.

Notice

- 1) To avoid using relays under strong magnetic field which will change the parameters of relays such as pick-up voltage and drop-out voltage.
- 2) Energizing coil with rated voltage is basic for normal operation of a relay, please make sure the energized voltage to relay coil have reached the rated voltage.
- 3) The relay may be damaged because of falling or when shocking conditions exceed the requirement.
- 4) Plastic sealed type is recommended for an environment with noxious gas such as H₂S, SO₂ and NO₂,ect., and/or when load current is low, and/or the PCB boards need to be washed after relays are soldered. For other using conditions flux proofed type could be adopted.
- 5) Contact is recommended for suitable condition and specifications if water cleaning or surface process is involved in assembling relays on PCB.
- 6) Regarding the plastic sealed relay, we should leave it cooling naturally untill below 40°C after welding, then clean it and deal with coating, remarkably the temperature of solvents should also be controlled below 40°C. Please avoid cleaning the relay by ultrasonic, avoid using the solvents like gasoline, Freon, and so on, which would affect the configuration of relay or influence the environment.
- 7) About preferable condition of operation, storage and transportation, please refer to "Explanation to terminology and guidetines of relay".
- 8) Please contact us for more details if you have different conditions of application.

Disclaimer

The specification is for reference only. See to "Terminology and Guidelines" for more information. Specifications subject to change without notice. We could not evaluate all the performance and all the parameters for every possible application. Thus the user should be in a right position to choose the suitable product for their own application. If there is any query, please contact Hongfa for the technical service. However, it is the user's responsibility to determine which product should be used only.