

## CP-series CP1E CPU Units CP1E-E@@SD@-@ CP1E-N@@S@D-@-@ CP1E-E@@D@-@ CP1E-N@@D@-@/NA20D@-@

### The CP1E Programmable Controller: Economical, Easy to use, and Efficient

- The E@@(S)-type Basic CPU Units provide cost performance and easy application with only basic functionality.
- The N@@(S@) and NA-types Application CPU Units support Programmable Terminal connection, position control, and inverter connection



### Features

- New CP1E CPU Units now available.
  - Lineup including CPU Units with built-in three ports: USB, RS-232C, RS-485.
  - The depth of CPU Units with RS-232C connectors is reduced by 20 mm. (N30/40/60S(1))
- Easy connection with computers using commercially available USB cables.
- With E30/40/60(S), N30/40/60(S@) or NA20 CPU Units, Add I/O, Analog I/O or Temperature Inputs by Connecting Expansion Units or Expansion I/O Units.
- Input interrupts
- Complete High-speed Counter Functionality.
- Versatile pulse control for Transistor Output for N14/20/30/40/60(S@) or NA20 CPU Units.
- PWM Outputs for Transistor Output for N14/20/30/40/60(S@) or NA20 CPU Units.
- Mounting Serial Option Boards, Ethernet Option Board and Analog Option Board to N30/40/60 or NA20 CPU Units.
- Built-in analog I/O, two inputs and one output, for NA-type CPU Units.

Windows is a registered trademark of Microsoft Corporation in the United States and other countries.  
 Other company names and product names in this document are the trademarks or registered trademarks of their respective companies.  
 The product photographs and figures that are used in this catalog may vary somewhat from the actual products.

# CP1E-E@@(S)D@-@ CP1E-N@@(S@)D@-@/NA20D@-@

## System Configuration

### ■ Basic Model

### Basic System Configuration Using an E@@S-type CPU Unit

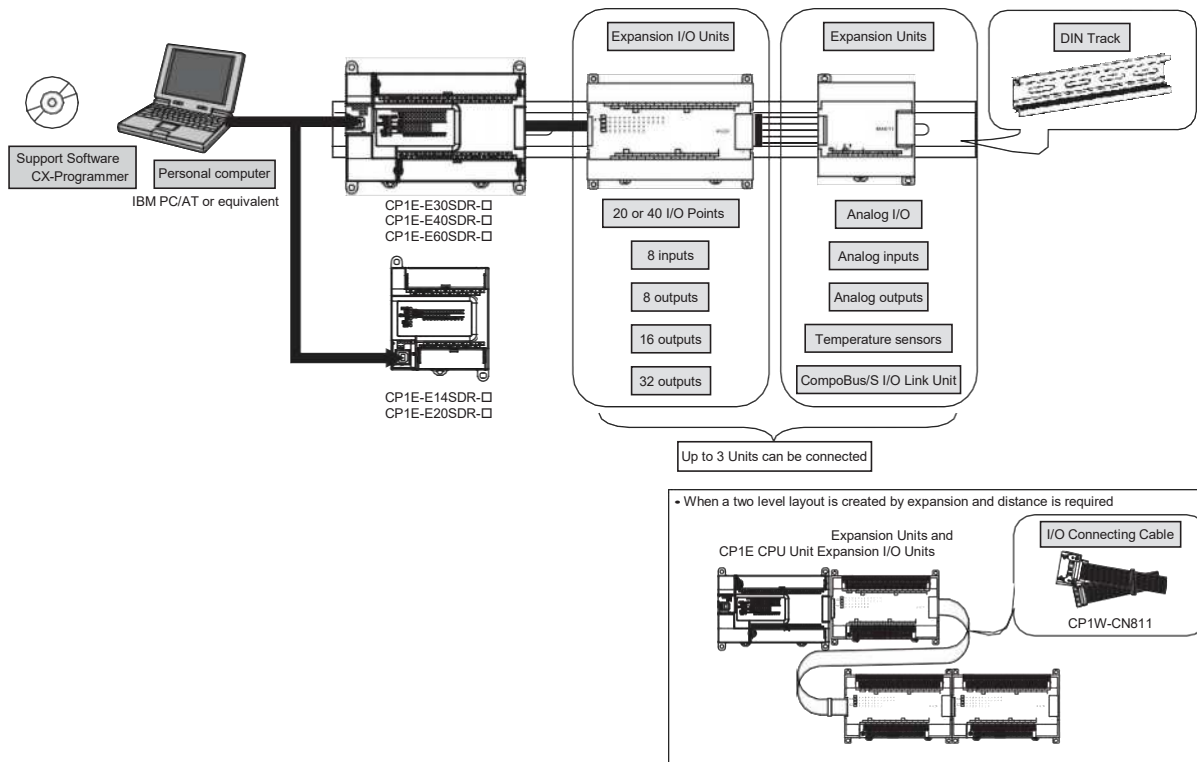

### Basic System Configuration Using an E@@-type CPU Unit

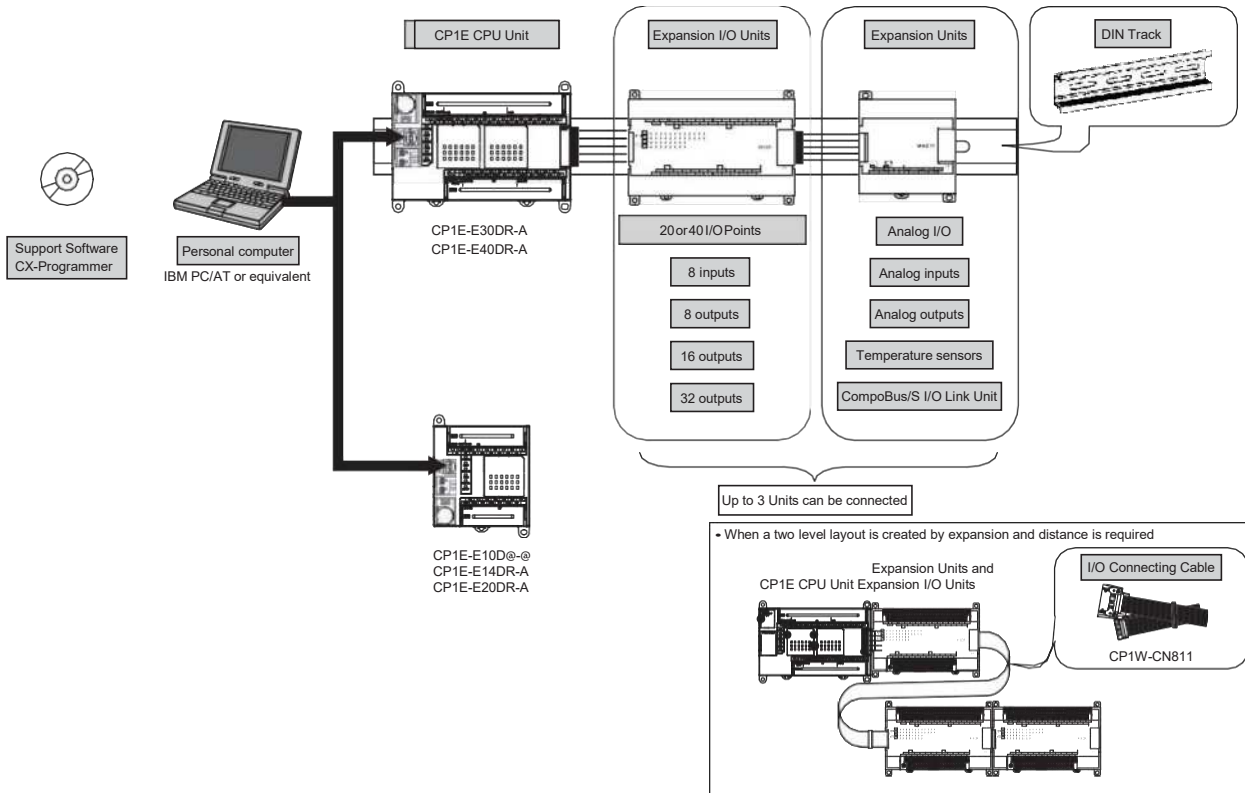

## Application Model

### Basic System Configuration Using an N/NA@@S(1)-type CPU Unit

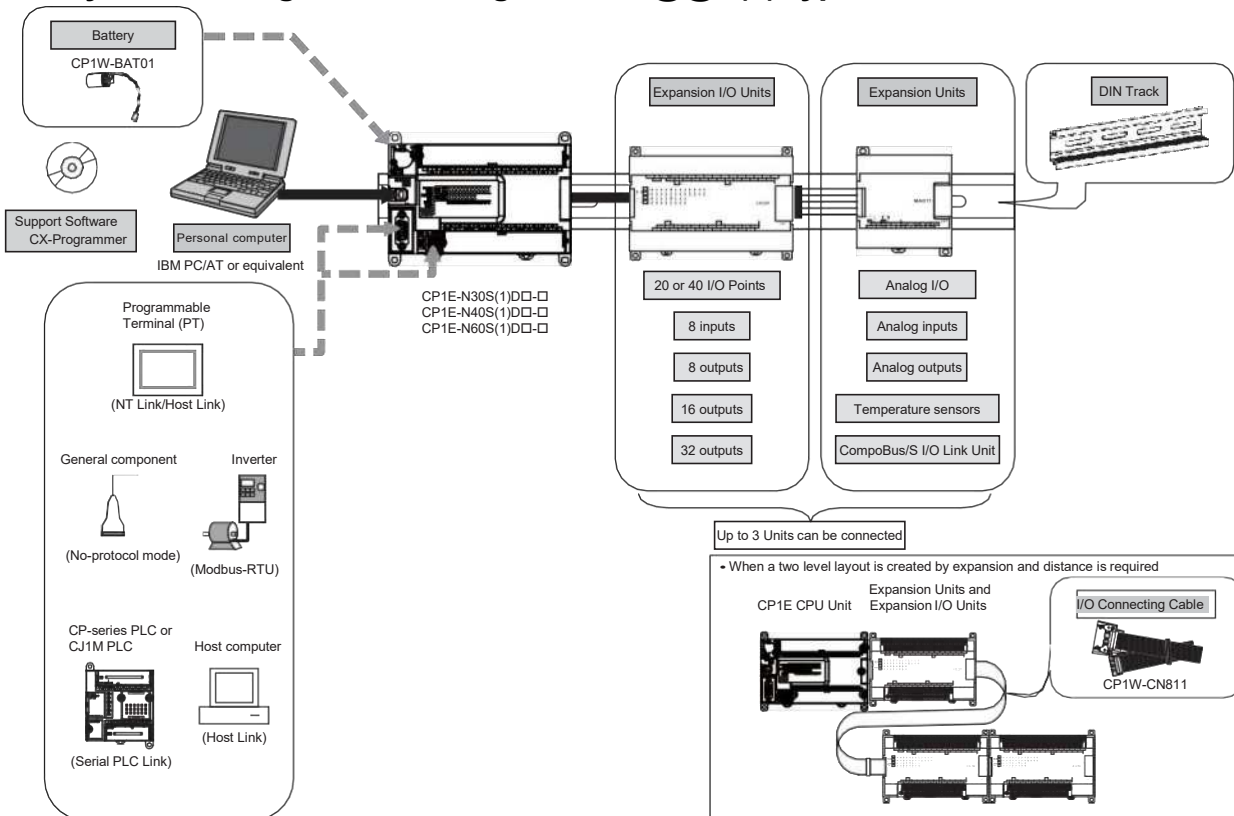

### Basic System Configuration Using an N/NA-type CPU Unit

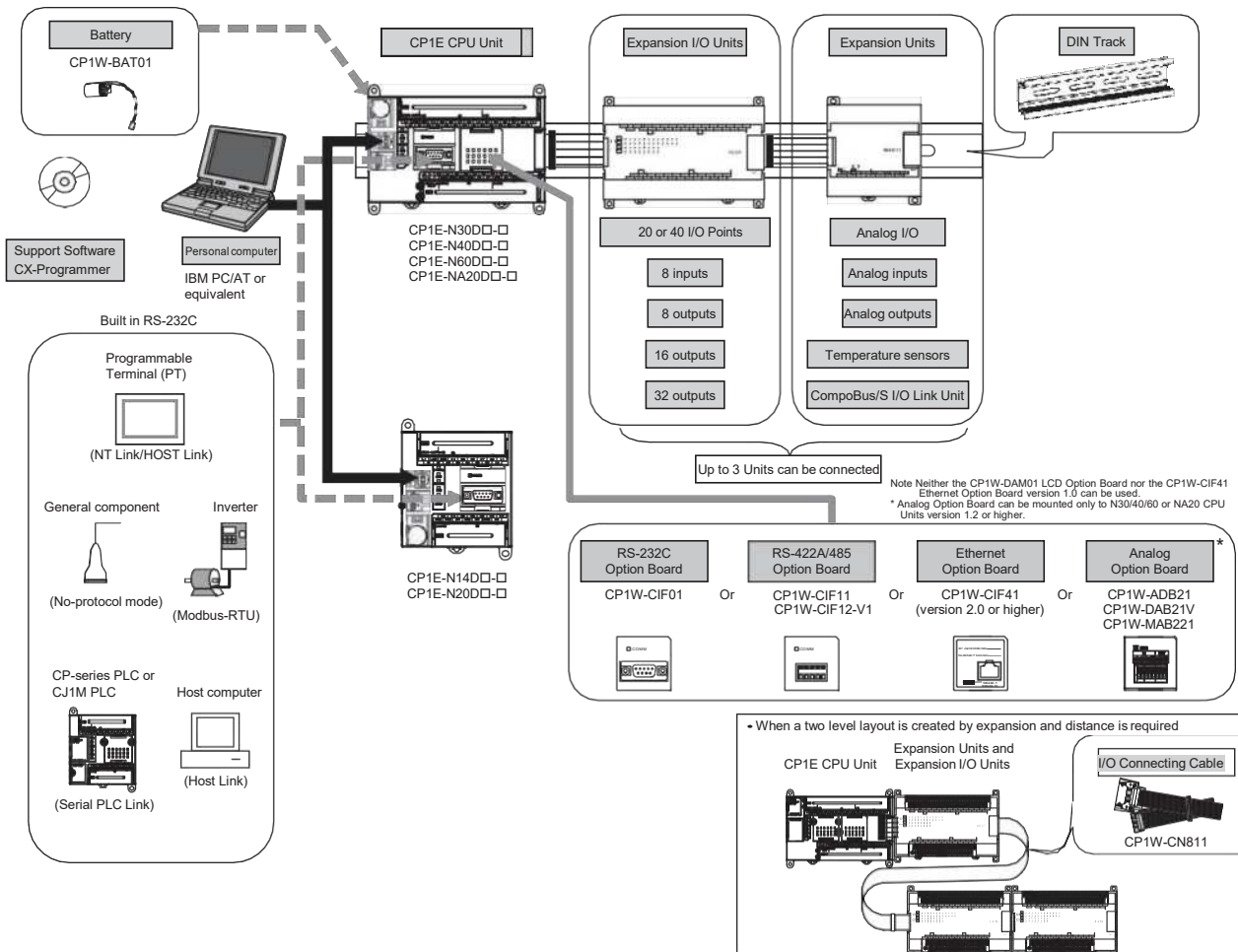

# CP1E-E@@(S)D@-@ CP1E-N@@(S@)D@-@/NA20D@-@

## Model Number Structure

■ Model Number Legend (Not all models that can be represented with the model number legend can necessarily be produced.)

### CP1E-@@@@@D@-@

(1) (2) (3) (4) (5) (6) (7)

- |   |   |   |
|---|---|---|
| <p>1. Class<br/>E : Basic model<br/>N : Application model<br/>NA : Application model with built-in analog</p> <p>2. I/O capacity<br/>10 : 10 I/O points (6 inputs, 4 outputs)<br/>14 : 14 I/O points (8 inputs, 6 outputs)<br/>20 : 20 I/O points (12 inputs, 8 outputs)<br/>30 : 30 I/O points (18 inputs, 12 outputs)<br/>40 : 40 I/O points (24 inputs, 16 outputs)<br/>60 : 60 I/O points (36 inputs, 24 outputs)</p> | <p>3. Unit type<br/>S : Renewal<br/>None : Normal</p> <p>4. Built-in RS-485 port<br/>1 : RS-485<br/>None : -</p> <p>5. Input type<br/>D : DC inputs</p> | <p>6. Output type<br/>R : Relays outputs<br/>T : Transistor outputs, sinking<br/>T1 : Transistor outputs, sourcing</p> <p>7. Power supply<br/>A : AC power supply<br/>D : DC power supply</p> |
|---|---|---|

## Difference between E/N/NA@@-type and E/N@@S(1)-type

### ■ Basic Model

#### E@@(S)-type CPU Units

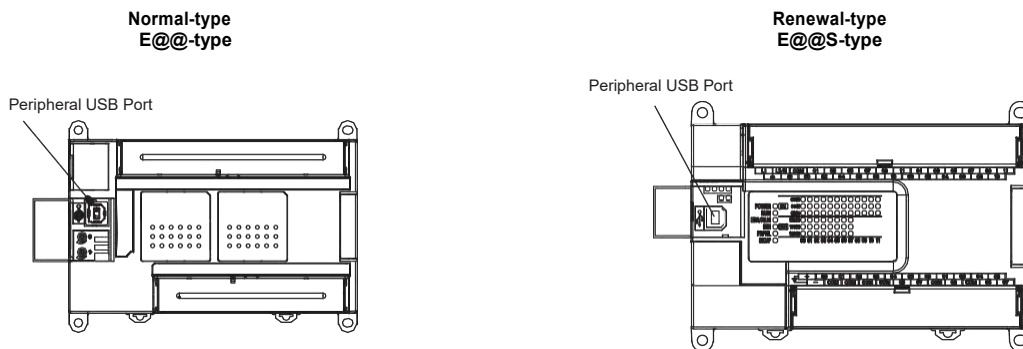

### Difference in Characteristics and Functions

Function	E@@-type (Normal)	E@@S-type (Renewal)
Analog adjusters	2 adjusters (Setting range: 0 to 255)	None The analog adjuster PV in A642/A643 is fixed on 0000.

### Product Lineup

	E@@ CPU Unit (Normal)				E@@S CPU Unit (Renewal)			
	Relay outputs		Transistor outputs (sinking/sourcing)		Relay outputs		Transistor outputs (sinking/sourcing)	
	AC	DC	AC	DC	AC	DC	AC	DC
10 I/O points	○	○	○	○	--	--	--	--
14 I/O points	○	--	--	--	○	--	--	--
20 I/O points	○	--	--	--	○	--	--	--
30 I/O points	○	--	--	--	○	--	--	--
40 I/O points	○	--	--	--	○	--	--	--
60 I/O points	--	--	--	--	○	--	--	--

## Application Model

### N/NA@@(S)-type CPU Units

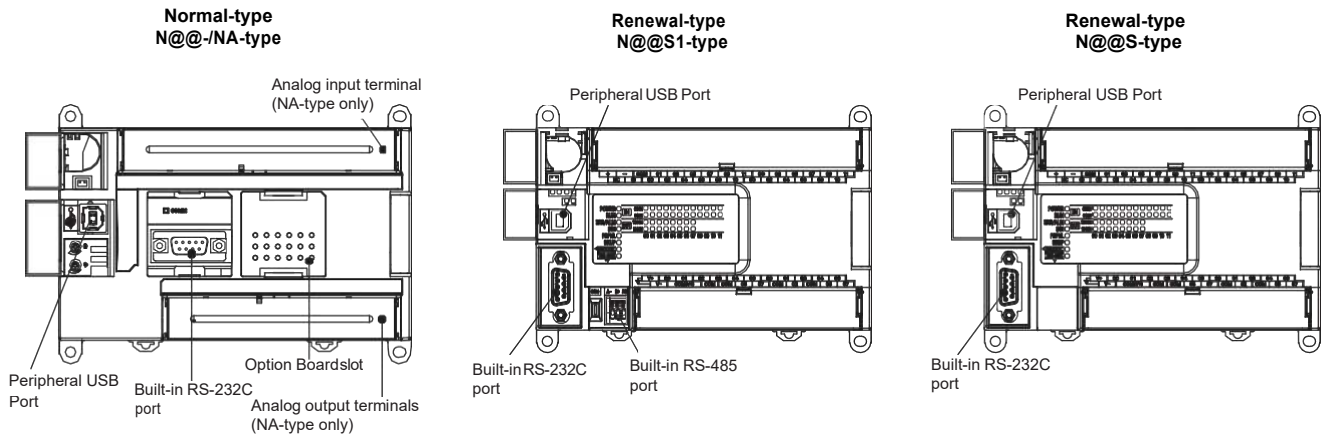

### Difference in Characteristics and Functions

Function		N/NA@@-type (Normal)	N@@S(1)-type (Renewal)																				
Analog adjusters		2 adjusters (Setting range: 0 to 255)	None The analog adjuster PV in A642/A643 is fixed on 0000.																				
Built-in RS-232C port		6 signals are supported: SD, RD, RS, CS, DR and ER.	4 signals are supported: SD, RD, RS and CS. DR (pin 7) and ER (pin 8) are not supported.																				
Option board		1 port (N30/40/60, NA20 CPU Unit only)	Cannot be mounted There is no slot for an option board.																				
Built-in RS-485 port		None	1 port (N30/40/60S1 CPU Unit only) With 2-wire connections, it can only communicate in half duplex. Terminating resistance ON/OFF can be set by DIP switch.																				
Terminal Arrangements (Transistor outputs only)	COM allocation	CIO 100.00 and CIO 100.01 correspond with different common terminals.  <table border="1" style="margin-left: auto; margin-right: auto;"> <tr><td>NC</td><td>00</td><td>01</td><td>02</td></tr> <tr><td>NC</td><td>COM</td><td>COM</td><td>COM</td></tr> <tr><td></td><td></td><td></td><td>03</td></tr> </table> <p style="text-align: center;">CIO 100.00 and CIO 100.01 are different COM.</p>	NC	00	01	02	NC	COM	COM	COM				03	CIO 100.00 and CIO 100.01 correspond with the same common terminal.  <table border="1" style="margin-left: auto; margin-right: auto;"> <tr><td>V+</td><td>00</td><td>01</td><td>02</td></tr> <tr><td>V-</td><td>COM(V-)</td><td>COM</td><td>03</td></tr> </table> <p style="text-align: center;">CIO 100.00 and CIO 100.01 are the same COM.</p>	V+	00	01	02	V-	COM(V-)	COM	03
	NC	00	01	02																			
NC	COM	COM	COM																				
			03																				
V+	00	01	02																				
V-	COM(V-)	COM	03																				
Power supply for transistor outputs	Not needed Do not connect an external power supply.	Needed It is necessary to connect a DC24V external power supply when using terminals 00 and 01 on terminal block CIO 100. Do not connect the external power supply to the terminals except 00 and 01 on terminal block CIO 100.																					

### Product Lineup

	Normal-type						Renewal-type							
	N@@ CPU Unit RS-232C+1 option slot (*)						N@@S CPU Unit Built-in RS-232C				N@@S1 CPU Unit Built-in RS-232C+RS-485			
	Relay outputs		Transistor outputs (sinking/sourcing)				Relay outputs		Transistor outputs (sinking/sourcing)		Relay outputs		Transistor outputs (sinking/sourcing)	
	Power supply	AC	DC	AC	DC	AC	DC	AC	DC	AC	DC	AC	DC	
10 I/O points	--	--	--	--	--	--	--	--	--	--	--	--	--	
14 I/O points	○	○	○	○	--	--	--	--	--	--	--	--	--	
20 I/O points	○	○	○	○	--	--	--	--	--	--	--	--	--	
30 I/O points	○	○	○	○	○	--	--	○	○	--	--	--	○	
40 I/O points	○	○	○	○	○	--	--	○	○	○	--	--	○	
60 I/O points	○	○	○	○	○	--	--	○	○	○	--	--	○	
20 I/O points (Built-in analog)	○	--	--	○	--	--	--	--	--	--	--	--	--	

\* 30, 40 and 60 I/O points only.

## Ordering Information





### Applicable standards

Refer to the OMRON website ([www.ia.omron.com](http://www.ia.omron.com)) or ask your OMRON representative for the most recent applicable standards for each model.

### Basic Model





### ● Renewal-type

### ■ E@@S-type CP1E CPU Units (Built-in USB port)

Product name	Specifications						External power supply (24 VDC) (A)	Current consumption (A)		Model
	Power Supply	Inputs	Outputs	Output type	Program capacity	Data memory capacity		5 V	24 V	
<b>E@@S-type CPU Units with 14 I/O Points</b> 	100 to 240 VAC	8	6	Relay	2K steps	2K words	--	0.16	0.07	<b>CP1E-E14SDR-A</b>
<b>E@@S-type CPU Units with 20 I/O Points</b> 	100 to 240 VAC	12	8	Relay	2K steps	2K words	--	0.17	0.08	<b>CP1E-E20SDR-A</b>
<b>E@@S-type CPU Units with 30 I/O Points</b> 	100 to 240 VAC	18	12	Relay	2K steps	2K words	0.30	0.17	0.07	<b>CP1E-E30SDR-A</b>
<b>E@@S-type CPU Units with 40 I/O Points</b> 	100 to 240 VAC	24	16	Relay	2K steps	2K words	0.30	0.17	0.09	<b>CP1E-E40SDR-A</b>
<b>E@@S-type CPU Units with 60 I/O Points</b> 	100 to 240 VAC	36	24	Relay	2K steps	2K words	0.30	0.17	0.13	<b>CP1E-E60SDR-A</b>

● Normal-type



■ E@@-type CP1E CPU Units (Built-in USB port)

Product name	Specifications						External power supply (24 VDC) (A)	Current consumption (A)		Model
	Power Supply	Inputs	Outputs	Output type	Program capacity	Data memory capacity		5 V	24 V	
<b>E@@-type CPU Units with 10 I/O Points</b> 	100 to 240 VAC	6	4	Relay	2K steps	2K words	--	0.08	0.04	<b>CP1E-E10DR-A</b>
				Transistor (sinking)			--	0.11	--	<b>CP1E-E10DT-A</b>
				Transistor (sourcing)			--	0.11	--	<b>CP1E-E10DT1-A</b>
	24 VDC			Relay			--	0.08	0.04	<b>CP1E-E10DR-D</b>
				Transistor (sinking)			--	0.11	--	<b>CP1E-E10DT-D</b>
				Transistor (sourcing)			--	0.11	--	<b>CP1E-E10DT1-D</b>
<b>E@@-type CPU Units with 14 I/O Points</b> 	100 to 240 VAC	8	6	Relay	2K steps	2K words	--	0.16	0.07	<b>CP1E-E14DR-A</b>
<b>E@@-type CPU Units with 20 I/O Points</b> 	100 to 240 VAC	12	8	Relay	2K steps	2K words	--	0.17	0.08	<b>CP1E-E20DR-A</b>
<b>E@@-type CPU Units with 30 I/O Points</b> 	100 to 240 VAC	18	12	Relay	2K steps	2K words	0.30	0.17	0.07	<b>CP1E-E30DR-A</b>
<b>E@@-type CPU Units with 40 I/O Points</b> 	100 to 240 VAC	24	16	Relay	2K steps	2K words	0.30	0.17	0.09	<b>CP1E-E40DR-A</b>



**Application Model**

● **Renewal-type**

■ **N@@S1-type CP1E CPU Units (Built-in RS-232C, RS-485, USB ports)**

Product name	Specifications						External power supply (24 VDC) (A)	Current consumption (A)		Model
	Power Supply	Inputs	Outputs	Output type	Program capacity	Data memory capacity		5 V	24 V	
<b>N@@S1-type CPU Units with 30 I/O Points</b> 	100 to 240 VAC	18	12	Relay	8K steps	8K words	0.30	0.21	0.07	<b>CP1E-N30S1DR-A</b>
	DC24V			Transistor (sinking)			--	0.27	0.02	<b>CP1E-N30S1DT-D</b>
				Transistor (sourcing)			--	0.27	0.02	<b>CP1E-N30S1DT1-D</b>
<b>N@@S1-type CPU Units with 40 I/O Points</b> 	100 to 240 VAC	24	16	Relay	8K steps	8K words	0.30	0.21	0.09	<b>CP1E-N40S1DR-A</b>
	DC24V			Transistor (sinking)			--	0.31	0.02	<b>CP1E-N40S1DT-D</b>
				Transistor (sourcing)			--	0.31	0.02	<b>CP1E-N40S1DT1-D</b>
<b>N@@S1-type CPU Units with 60 I/O Points</b> 	100 to 240 VAC	36	24	Relay	8K steps	8K words	0.30	0.21	0.13	<b>CP1E-N60S1DR-A</b>
	DC24V			Transistor (sinking)			--	0.31	0.02	<b>CP1E-N60S1DT-D</b>
				Transistor (sourcing)			--	0.31	0.02	<b>CP1E-N60S1DT1-D</b>





■ **N@@S-type CP1E CPU Units (Built-in RS-232C, USB ports)**

Product name	Specifications						External power supply (24 VDC) (A)	Current consumption (A)		Model
	Power Supply	Inputs	Outputs	Output type	Program capacity	Data memory capacity		5 V	24 V	
<b>N@@S-type CPU Units with 30 I/O Points</b> 	100 to 240 VAC	18	12	Relay	8K steps	8K words	0.30	0.21	0.07	<b>CP1E-N30SDR-A</b>
	DC24V			Transistor (sinking)			--	0.27	0.02	<b>CP1E-N30SDT-D</b>
				Transistor (sourcing)			--	0.27	0.02	<b>CP1E-N30SDT1-D</b>
<b>N@@S-type CPU Units with 40 I/O Points</b> 	100 to 240 VAC	24	16	Relay	8K steps	8K words	0.30	0.21	0.09	<b>CP1E-N40SDR-A</b>
	DC24V			Transistor (sinking)			--	0.31	0.02	<b>CP1E-N40SDT-D</b>
				Transistor (sourcing)			--	0.31	0.02	<b>CP1E-N40SDT1-D</b>
<b>N@@S-type CPU Units with 60 I/O Points</b> 	100 to 240 VAC	36	24	Relay	8K steps	8K words	0.30	0.21	0.13	<b>CP1E-N60SDR-A</b>
	DC24V			Transistor (sinking)			--	0.31	0.02	<b>CP1E-N60SDT-D</b>
				Transistor (sourcing)			--	0.31	0.02	<b>CP1E-N60SDT1-D</b>





● Normal-type

■ N/NA@@-type CP1E CPU Units (Built-in RS-232C, USB ports)

Product name	Specifications						External power supply (24 VDC) (A)	Current consumption (A)		Model
	Power Supply	Inputs	Outputs	Output type	Program capacity	Data memory capacity		5 V	24 V	
<b>N@@-type CPU Units with 14 I/O Points</b> 	100 to 240 VAC	8	6	Relay	8K steps	8K words	--	0.17	0.07	CP1E-N14DR-A
				Transistor (sinking)			--	0.22	0.02	CP1E-N14DT-A
				Transistor (sourcing)			--	0.22	0.02	CP1E-N14DT1-A
	24 VDC			Relay			--	0.17	0.07	CP1E-N14DR-D
				Transistor (sinking)			--	0.22	0.02	CP1E-N14DT-D
				Transistor (sourcing)			--	0.22	0.02	CP1E-N14DT1-D
<b>N@@-type CPU Units with 20 I/O Points</b> 	100 to 240 VAC	12	8	Relay	8K steps	8K words	--	0.18	0.08	CP1E-N20DR-A
				Transistor (sinking)			--	0.23	0.02	CP1E-N20DT-A
				Transistor (sourcing)			--	0.23	0.02	CP1E-N20DT1-A
	24 VDC			Relay			--	0.18	0.08	CP1E-N20DR-D
				Transistor (sinking)			--	0.23	0.02	CP1E-N20DT-D
				Transistor (sourcing)			--	0.23	0.02	CP1E-N20DT1-D
<b>N@@-type CPU Units with 30 I/O Points</b> 	100 to 240 VAC	18	12	Relay	8K steps	8K words	0.30	0.21	0.07	CP1E-N30DR-A
				Transistor (sinking)			0.30	0.27	0.02	CP1E-N30DT-A
				Transistor (sourcing)			0.30	0.27	0.02	CP1E-N30DT1-A
	24 VDC			Relay			--	0.21	0.07	CP1E-N30DR-D
				Transistor (sinking)			--	0.27	0.02	CP1E-N30DT-D
				Transistor (sourcing)			--	0.27	0.02	CP1E-N30DT1-D
<b>N@@-type CPU Units with 40 I/O Points</b> 	100 to 240 VAC	24	16	Relay	8K steps	8K words	0.30	0.21	0.09	CP1E-N40DR-A
				Transistor (sinking)			0.30	0.31	0.02	CP1E-N40DT-A
				Transistor (sourcing)			0.30	0.31	0.02	CP1E-N40DT1-A
	24 VDC			Relay			--	0.21	0.09	CP1E-N40DR-D
				Transistor (sinking)			--	0.31	0.02	CP1E-N40DT-D
				Transistor (sourcing)			--	0.31	0.02	CP1E-N40DT1-D

# CP1E-E@@(S)D@-@ CP1E-N@@(S@)D@-@/NA20D@-@

Product name	Specifications						External power supply (24 VDC) (A)	Current consumption (A)		Model
	Power Supply	Inputs	Outputs	Output type	Program capacity	Data memory capacity		5 V	24 V	
<b>N@@-type CPU Units with 60 I/O Points</b> 	100 to 240 VAC	36	24	Relay	8K steps	8K words	0.30	0.21	0.13	<b>CP1E-N60DR-A</b>
				Transistor (sinking)			0.30	0.31	0.02	<b>CP1E-N60DT-A</b>
				Transistor (sourcing)			0.30	0.31	0.02	<b>CP1E-N60DT1-A</b>
	24 VDC			Relay			--	0.21	0.13	<b>CP1E-N60DR-D</b>
				Transistor (sinking)			--	0.31	0.02	<b>CP1E-N60DT-D</b>
				Transistor (sourcing)			--	0.31	0.02	<b>CP1E-N60DT1-D</b>
<b>NA-type CPU Units with 20 I/O Points (Built-in analog)</b> 	100 to 240 VAC	12 (Built-in analog inputs: 2)	8 (Built-in analog outputs: 1)	Relay	8K steps	8K words	0.30	0.18	0.11	<b>CP1E-NA20DR-A</b>
	24 VDC			Transistor (sinking)			--	0.23	0.09	<b>CP1E-NA20DT-D</b>
				Transistor (sourcing)			--	0.23	0.09	<b>CP1E-NA20DT1-D</b>







## Optional Products

### ■ Battery Set

Product name	Specifications	Model
<b>Battery Set</b> 	For N/NA@@(S@)-type CP1E CPU Units <b>Note:</b> Mount a Battery to an N/NA@@(S@)-type CPU Unit if the data in the following areas must be backed up for power interruptions. <ul style="list-style-type: none"> <li>DM Area (D) (except backed up words in the DM Area), Holding Area (H), Counter Completion Flags (C), Counter Present Values (C), Auxiliary Area (A), and Clock Function (Use batteries within two years of manufacture.)</li> </ul>	<b>CP1W-BAT01</b>

### ■ Option Board (for CP1E N30/40/60 or NA20 CPU Units)



The Options cannot be used for CP1E N14/20, N30/40/60S(1), E10/14/20/30/40/60(S) CPU Units.

Product name	Specifications	Model
<b>RS-232C Option Board</b> 	One RS-232C Option Board can be mounted to the Option Board slot.	<b>CP1W-CIF01</b>
<b>RS-422A/485 Option Board</b> 	One RS-422A/485 Option Board can be mounted to the Option Board slot.	<b>CP1W-CIF11</b>
<b>RS-422A/485 Isolated-type Option Board</b> 		<b>CP1W-CIF12-V1</b>
<b>Ethernet Option Board</b> 	One Ethernet Option Board can be mounted to the Option Board slot. CP1E CPU Units are supported by CP1W-CIF41 version 2.0 or higher. When using CP1W-CIF41, CX-Programmer version 9.12 or higher is required.	<b>CP1W-CIF41</b>
<b>Analog Input Option Board</b> 	Can be mounted in CPU Unit Option Board slot. 2 analog inputs. 0-10V(Resolution:1/4000), 0-20mA (Resolution:1/2000).	<b>CP1W-ADB21 *</b>
<b>Analog Output Option Board</b> 	Can be mounted in CPU Unit Option Board slot. 2 analog outputs. 0-10V (Resolution:1/4000).	<b>CP1W-DAB21V *</b>
<b>Analog I/O Option Board</b> 	Can be mounted in CPU Unit Option Board slot. 2 analog inputs. 0-10V(Resolution:1/4000), 0-20mA(Resolution:1/2000). 2 analog outputs. 0-10V (Resolution:1/4000).	<b>CP1W-MAB221 *</b>

**Note:** It is not possible to use a CP-series Ethernet Option Board version 1.0 (CP1W-CIF41), LCD Option Board (CP1W-DAM01), or Memory Card (CP1W-ME05M) with a CP1E CPU Unit.

\* Support is provided with CP1E CPU Unit version 1.2 and later.

■ Expansion I/O Units and Expansion Units (for CP1E E30/40/60(S), N30/40/60(S@), or NA20 CPU Units)  
 CP1E E10/14/20(S) or N14/20 CPU Units do not support Expansion I/O Units and Expansion Units.

Unit type	Product name	Specifications			Current consumption (A)		Model		
		Inputs	Outputs	Output type	5 V	24 V			
CP1W Expansion I/O Units	<b>Input Unit</b> 	8	--	24 VDC Input	0.018	--	CP1W-8ED		
	<b>Output Units</b> 	--	8	Relay	0.026	0.044	CP1W-8ER		
				Transistor (sinking)	0.075	--	CP1W-8ET		
				Transistor (sourcing)	0.075	--	CP1W-8ET1		
		--	16	Relay	0.042	0.090	CP1W-16ER		
				Transistor (sinking)	0.076	--	CP1W-16ET		
				Transistor (sourcing)	0.076	--	CP1W-16ET1		
		--	32	Relay	0.049	0.131	CP1W-32ER		
				Transistor (sinking)	0.113	--	CP1W-32ET		
				Transistor (sourcing)	0.113	--	CP1W-32ET1		
	<b>I/O Units</b> 	12	8	Relay	0.103	0.044	CP1W-20EDR1		
				Transistor (sinking)	0.130	--	CP1W-20EDT		
				Transistor (sourcing)	0.130	--	CP1W-20EDT1		
		24	16	Relay	0.080	0.090	CP1W-40EDR		
Transistor (sinking)				0.160	--	CP1W-40EDT			
Transistor (sourcing)	0.160			--	CP1W-40EDT1				
CP1W Expansion Units	<b>Analog Input Unit</b> 	4CH	--	Input range: 0 to 5 V, 1 to 5 V, 0 to 10 V, ±10 V, 0 to 20 mA, or 4 to 20 mA.	Resolution: 1/6000	0.100	0.090	CP1W-AD041	
					Resolution: 1/12000	0.100	0.050	CP1W-AD042	
	<b>Analog Output Unit</b> 	--	2CH	4CH	Output range: 1 to 5 V, 0 to 10 V, ±10 V, 0 to 20 mA, or 4 to 20 mA.	Resolution: 1/6000	0.040	0.095	CP1W-DA021
						Resolution: 1/6000	0.080	0.124	CP1W-DA041
						Resolution: 1/12000	0.070	0.160	CP1W-DA042
	<b>Analog I/O Unit</b> 	4CH	4CH	4CH	Input range: 0 to 5 V, 1 to 5 V, 0 to 10 V, ±10 V, 0 to 20 mA, or 4 to 20 mA. Output range: 1 to 5 V, 0 to 10 V, ±10 V, 0 to 20 mA, or 4 to 20 mA.	Resolution: 1/12000	0.120	0.170	CP1W-MAD44
			2CH	2CH		Resolution: 1/12000	0.120	0.120	CP1W-MAD42
			2CH	1CH		Resolution: 1/6000	0.083	0.110	CP1W-MAD11
	<b>Temperature Sensor Unit</b> 	2CH	--	Sensor type: Thermocouple (J or K)		0.040	0.059	CP1W-TS001	
				Sensor type: Thermocouple (J or K)		0.040	0.059	CP1W-TS002	
		4CH	--	Sensor type: Platinum resistance thermometer (Pt100 or JPt100)		0.054	0.073	CP1W-TS101	
				Sensor type: Platinum resistance thermometer (Pt100 or JPt100)		0.054	0.073	CP1W-TS102	
		4CH	--	Sensor type: Thermocouple (J or K)	2channels can be used as analog input. Input range: 1 to 5 V, 0 to 10 V, 4-20 mA	Resolution: 1/12000	0.070	0.030	CP1W-TS003
				Sensor type: Thermocouple (J or K)					
<b>CompoBus/S I/O Link Unit</b> 	8	8	CompoBus/S slave		0.029	--	CP1W-SRT21		

■ I/O Connecting Cable

Product name	Specifications	Model
I/O Connecting Cable	80 cm (for CP1W Expansion I/O Units and Expansion Units) Only one I/O Connecting Cable can be used in each PLC.	CP1W-CN811

Note: An I/O Connecting Cable (approx. 6 cm) for horizontal connection is provided with CP1W Expansion I/O Units and Expansion Units.

## ■ DIN Track Accessories

Name	Specifications	Model
DIN Track	Length: 0.5 m; Height: 7.3 mm	PFP-50N
	Length: 1 m; Height: 7.3 mm	PFP-100N
	Length: 1 m; Height: 16 mm	PFP-100N2
End Plate	A stopper to secure the Units on the DIN Track.	PFP-M

## Programming Devices

### Software

Product name	Specifications	Number of licenses	Media	Model
<b>FA Integrated Tool Package CX-One Lite Ver.4.@</b>	CX-One Lite is a subset of the complete CX-One package that provides only the Support Software required for micro PLC applications. CX-One Lite runs on the following OS. OS: Windows XP (Service Pack 3 or higher, 32-bit version) / Windows Vista (32-bit/64-bit version) / Windows 7 (32-bit/64-bit version) / Windows 8 (32-bit/64-bit version) / Windows 8.1 (32-bit/64-bit version) / Windows 10 (32-bit/64-bit version) CX-One Lite Ver. 4.@ includes Micro PLC Edition CX-Programmer Ver.9.@.	1 license	DVD	<b>CXONE-LT01D-V4</b>
<b>FA Integrated Tool Package CX-One Package Ver. 4.@</b>	CX-One is a comprehensive software package that integrates Support Software for OMRON PLCs and components. CX-One runs on the following OS. OS: Windows XP (Service Pack 3 or higher, 32-bit version) / Windows Vista (32-bit/64-bit version) / Windows 7 (32-bit/64-bit version) / Windows 8 (32-bit/64-bit version) / Windows 8.1 (32-bit/64-bit version) / Windows 10 (32-bit/64-bit version) CX-One Ver. 4.@ includes CX-Programmer Ver. 9.@.	1 license *	DVD	<b>CXONE-AL01D-V4</b>

**Note:** 1. The E20/30/40(S), N20/N30/N40(S) CPU Units are supported by CX-Programmer version 8.2 or higher.  
The E10, E14, N14, N60, and NA20 CPU Units are supported by CX-Programmer version 9.03 or higher. When Micro PLC Edition CX-Programmer is used, you need version 9.03 or higher.  
The E60S CPU Units are supported by CX-Programmer version 9.42 or higher. When Micro PLC Edition CX-Programmer is used, you need version 9.42 or higher.

2. The CX-One and CX-One Lite cannot be simultaneously installed on the same computer.

\* Multi licenses (3, 10, 30, or 50 licenses) and DVD media without licenses are also available for the CX-One.

The following tables lists the Support Software that can be installed from CX-One

Support Software in CX-One	CX-One Lite Ver.4.@	CX-One Ver.4.@	Support Software in CX-One	CX-One Lite Ver.4.@	CX-One Ver.4.@
Micro PLC Edition CX-Programmer Ver.9.@	Yes	No	CX-Drive Ver.1.@	Yes	Yes
CX-Programmer Ver.9.@	No	Yes	CX-Process Tool Ver.5.@	No	Yes
CX-Integrator Ver.2.@	Yes	Yes	Faceplate Auto-Builder for NS Ver.3.@	No	Yes
Switch Box Utility Ver.1.@	Yes	Yes	CX-Designer Ver.3.@	Yes	Yes
CX-Protocol Ver.1.@	No	Yes	NV-Designer Ver.1.@	Yes	Yes
CX-Simulator Ver.1.@	Yes	Yes	CX-Thermo Ver.4.@	Yes	Yes
CX-Position Ver.2.@	No	Yes	CX-ConfiguratorFDT Ver.1.@	Yes	Yes
CX-Motion-NCF Ver.1.@	No	Yes	CX-FLnet Ver.1.@	No	Yes
CX-Motion-MCH Ver.2.@	No	Yes	Network Configurator Ver.3.@	Yes	Yes
CX-Motion Ver.2.@	No	Yes	CX-Server Ver.4.@	Yes	Yes

**Note:** For details, refer to the CX-One Catalog (Cat. No. R134).

## Unit Versions

Units	Model numbers	Unit version
CP1E CPU Units	CP1E-E@@SDR-A CP1E-N@@SD@-@ CP1E-E@@D@-@ CP1E-N@@D@-@ CP1E-NA@@D@-@	Unit version 1.@

## Unit Versions and Programming Devices

The following tables show the relationship between unit versions and CX-Programmer versions.

CPU Unit	Functions	Required Programming Device *1						
		CX-Programmer			Micro PLC Edition CX-Programmer			CX-Programmer for CP1E
		Ver.8.2 or higher	Ver.9.03 or higher	Ver.9.42 or higher	Ver.8.2 or higher	Ver.9.03 or higher	Ver.9.42 or higher	Ver.1.0
CP1E-E20/30/40(S)D@-A CP1E-N20/30/40(S@)D@-@	Unit version 1.@ functions	Yes *3	Yes *2	Yes *2	Yes *3	Yes *2	Yes *2	Yes *2
CP1E-E10D@-@ CP1E-@14(S)D@-@ CP1E-N60(S@)D@-@ CP1E-NA20D@-@	Unit version 1.@ functions	No	Yes *2	Yes *2	No	Yes *2	Yes *2	No
CP1E-E60SDR-A	Unit version 1.@ functions	No	No	Yes *2	No	No	Yes *2	No

**Note:** 1. To update the CX-Programmer, the CX-One version 3/version 4 auto-update must be installed.

2. Use the CX-Programmer version 9.12 or higher, when the CP1W-CIF41 is applied.

\* 1 A Programming Console cannot be used.

\* 2 Supports Smart Input function.

\* 3 Does not support Smart Input function.

# CP1E-E@@(S)D@-@ CP1E-N@@(S@)D@-@NA20D@-@

## General Specifications

Type	AC power supply models		DC power supply models	
Model	CP1E-@@@S@D@-A CP1E-@@@D@-A		CP1E-@@@S@D@-D CP1E-@@@D@-D	
Enclosure	Mounted in a panel			
Dimensions (H × D × W)	<p>E/N/NA@@-type</p> <p>CPU Unit with 10 I/O points (CP1E-E10D@-@): 90mm *1 × 85mm *2 × 66 mm</p> <p>CPU Unit with 14 or 20 I/O points (CP1E-@14D@-@/@20D@-@): 90mm *1 × 85mm *2 × 86 mm</p> <p>CPU Unit with 30 I/O points (CP1E-@30D@-@): 90mm *1 × 85mm *2 × 130 mm</p> <p>CPU Unit with 40 I/O points (CP1E-@40D@-@): 90mm *1 × 85mm *2 × 150 mm</p> <p>CPU Unit with 60 I/O points (CP1E-N60D@-@): 90mm *1 × 85mm *2 × 195 mm</p> <p>CPU Unit with 20 I/O points and built-in analog (CP1E-NA20D@-@): 90mm *1 × 85mm *2 × 130 mm</p> <p>E/N/@@S(1)-type</p> <p>CPU Unit with 14 or 20 I/O points (CP1E-@14SD@-@/@20SD@-@): 90mm *1 × 79mm *2 × 86 mm</p> <p>CPU Unit with 30 I/O points (CP1E-@30S(1)D@-@): 90mm *1 × 79mm *2 × 130 mm</p> <p>CPU Unit with 40 I/O points (CP1E-@40S(1)D@-@): 90mm *1 × 79mm *2 × 150 mm</p> <p>CPU Unit with 60 I/O points (CP1E-@60S(1)D@-@): 90mm *1 × 79mm *2 × 195 mm</p>			
Weight	<p>CPU Unit with 10 I/O points (CP1E-E10D@-@): 300g max.</p> <p>CPU Unit with 14 I/O points (CP1E-@14(S)D@-@): 360g max.</p> <p>CPU Unit with 20 I/O points (CP1E-@20(S)D@-@): 370g max.</p> <p>CPU Unit with 30 I/O points (CP1E-@30(S)D@-@): 600g max.</p> <p>CPU Unit with 40 I/O points (CP1E-@40(S)D@-@): 660g max.</p> <p>CPU Unit with 60 I/O points (CP1E-@60(S)D@-@): 850g max.</p> <p>CPU Unit with 20 I/O points and built-in analog (CP1E-NA20D@-@): 680g max.</p>			
Electrical specifications	Supply voltage	100 to 240 VAC 50/60 Hz	24 VDC	
	Operating voltage range	85 to 264 VAC	20.4 to 26.4 VDC	
	Power consumption	15 VA/100 VAC max. 25 VA/240 VAC max. (CP1E-E10D@-A/@14(S)D@-A/@20(S)D@-A)	9 W max. (CP1E-E10D@-D) 13 W max. (CP1E-N14D@-D/N20D@-D)	
		50 VA/100 VAC max. 70 VA/240 VAC max. (CP1E-NA20D@-A/@30(S)D@-A/@40(S)D@-A/ N60(S)D@-A)	20 W max. (CP1E-NA20D@-D/N30(S)D@-D/N40(S)D@-D/ N60(S)D@-D) *4	
	Inrush current	120 VAC, 20 A for 8 ms max. for cold start at room temperature 240 VAC, 40 A for 8 ms max. for cold start at room temperature	24 VDC, 30 A for 20 ms max. for cold start at room temperature	
	External power supply *3	Not provided. (CP1E-E10D@-A/@14(S)D@-A/@20(S)D@-A) 24 VDC, 300 mA (CP1E-NA20D@-A/@30D@-A/@40D@-A/@60D@-A/ @30SDR@-A/@40SDR@-A/@60SDR@-A)	Not provided	
	Insulation resistance	20 MΩ min. (at 500 VDC) between the external AC terminals and GR terminals	Except between DC primary current and DC secondary current	
	Dielectric strength	2,300 VAC 50/60Hz for 1 min between AC external and GR terminals Leakage current: 5 mA max.	Except between DC primary current and DC secondary current	
Power OFF detection time	10 ms min.	2 ms min.		
Application environment	Ambient operating temperature	0 to 55 °C		
	Ambient humidity	10% to 90%		
	Atmosphere	No corrosive gas.		
	Ambient storage temperature	-20 to 75 °C (excluding battery)		
	Altitude	2,000 m max.		
	Pollution degree	2 or less: Meets IEC 61010-2-201.		
	Noise resistance	2 kV on power supply line (Conforms to IEC61000-4-4.)		
	Overvoltage category	Category II: Meets IEC 61010-2-201.		
	EMC Immunity Level	Zone B		
	Vibration resistance	Conforms to JIS 60068-2-6. 5 to 8.4 Hz with 3.5-mm amplitude, 8.4 to 150 Hz Acceleration of 9.8 m/s <sup>2</sup> for 100 min in X, Y, and Z directions (10 sweeps of 10 min each = 100 min total)		
Shock resistance	Conforms to JIS 60068-2-27. 147 m/s <sup>2</sup> , 3 times in X, Y, and Z directions			
Terminal block	Fixed (not removable)			
Terminal screw size	M3			
Applicable standards	Conforms to EC Directive			
Grounding method	Ground to 100 Ω or less.			

\* 1 Total of 110 mm with mounting brackets.

\* 2 Excluding cables.

\* 3 Use the external power supply to power input devices. Do not use it to drive output devices.

\* 4 This is the rated value for the maximum system configuration. Use the following formula to calculate power consumption for CPU Units with DC power.  
Formula: DC power consumption = (5V current consumption × 5 V/70% (internal power efficiency) + 24V current consumption) × 1.1(current fluctuation factor)

The above calculation results show that a DC power supply with a greater capacity is required.

# CP1E-E@@(S)D@-@ CP1E-N@@(S@)D@-@/NA20D@-@

## Performance Specifications

Item		CP1E-E@@SD@-@ CP1E-@@D@-@	CP1E-N@@S@D@-@ CP1E-N@@D@-@ CP1E-NA@@D@-@	
Program capacity		2 K steps (8 Kbytes) including the symbol table, comments, and program indices of the CX-Programmer	8 K steps (32 Kbytes) including the symbol table, comments, and program indices of the CX-Programmer	
Control method		Stored program method		
I/O control method		Cyclic scan with immediate refreshing		
Program language		Ladder diagram		
Instructions		Approximately 200		
Processing speed	Overhead processing time	0.4 ms		
	Instruction execution times	Basic instructions (LD): 1.19 µs min. Special instructions (MOV): 7.9 µs min.		
Number of CP1W-series Expansion Units connected		CP1E-E10D@-@/14(S)D@-@/20(S)D@-@: None CP1E-@30(S@)D@-@/40(S@)D@-@/60(S@)D@-@/NA20(S@)D@-@: 3 units		
Maximum number of I/O points		CP1E-E10D@-@ : 10 CP1E-@14(S)D@-@: 14 CP1E-@20(S)D@-@: 20 CP1E-@30(S@)D@-@: 150 (30 built in, 40 × 3 expansion) CP1E-@40(S@)D@-@: 160 (40 built in, 40 × 3 expansion) CP1E-@60(S@)D@-@: 180 (60 built in, 40 × 3 expansion) CP1E-NA20D@-@: 140 (20 built in, 40 × 3 expansion)		
Built-in I/O		CP1E-E10D@-@ : 10 (6 inputs, 4 outputs) CP1E-@14(S)D@-@: 14 (8 inputs, 6 outputs) CP1E-@20(S)D@-@: 20 (12 inputs, 8 outputs) CP1E-@30(S@)D@-@: 30 (18 inputs, 12 outputs) CP1E-@40(S@)D@-@: 40 (24 inputs, 16 outputs) CP1E-@60(S@)D@-@: 60 (36 inputs, 24 outputs) CP1E-NA20D@-@: 20 (12 inputs, 8 outputs)		
Built-in input functions	High-speed counters	High-speed counter mode/ maximum frequency	Incremental Pulse Inputs 10 kHz: 6 counters 5 counters (only for 10 I/O points) Up/Down Inputs 10 kHz: 2 counters Pulse + Direction Inputs 10 kHz: 2 counters Differential Phase Inputs (4x) 5 kHz: 2 counters	Incremental Pulse Inputs 100 kHz: 2 counters, 10 kHz: 4 counters  Up/Down Inputs 100 kHz: 1 counters, 10 kHz: 1 counters Pulse + Direction Inputs 100 kHz: 2 counters Differential Phase Inputs (4x) 50 kHz: 1 counter, 5 kHz: 1 counter
		Counting mode	Linear mode Ring mode	
		Count value	32 bits	
		Counter reset modes	Phase Z and software reset (excluding increment pulse input) Software reset	
		Control method	Target Matching Range Comparison	
	Input interrupts	6 inputs (4 inputs only for 10 I/O points) Interrupt input pulse width: 50 µs min.		
	Quick-response Inputs	6 inputs (4 inputs only for 10 I/O points) Input pulse width: 50 µs min.		
	Normal input	Input constants	Delays can be set in the PLC Setup (0 to 32 ms, default: 8 ms). Set values: 0, 1, 2, 4, 8, 16, or 32 ms	
Built-in output functions	Pulse outputs (Models with transistor outputs only)	Pulse output method and output frequency		Pulse + Direction Mode 1 Hz to 100 kHz: 2 outputs
		Output mode		Continuous mode (for speed control) Independent mode (for position control)
		Number of output pulses	Pulse output function not included	Relative coordinates: 0000 0000 to 7FFF FFFF hex (0 to 2147483647) Absolute coordinates: 8000 0000 to 7FFF FFFF hex (-2147483647 to 2147483647)
		Acceleration/ deceleration curves		Trapezoidal acceleration and deceleration (Cannot perform S-curve acceleration and deceleration.)
		Changing SVs during instruction execution		Only target position can be changed.
		Origin searches		Included
	Pulse outputs (Models with transistor outputs only)	Frequency		2.0 to 6,553.5 Hz (in increments of 0.1 Hz) with 1 output or 2 Hz to 32,000 Hz (in increments of 1 Hz) with 1 output
		Duty factor	PWM output function not included	0.0% to 100.0% (in increments of 0.1%) Accuracy: +1%/-0% at 2 Hz to 10,000 Hz and +5%/-0% at 10,000 Hz to 32,000 kHz
		Output mode		Continuous Mode
	Built-in analog	Analog input	Analog function not included	
Analog output		Setting range: 0 to 6,000 (1 channels only for NA-type)		
Analog adjusters		E/N/NA@@-type: 2 adjusters (Setting range: 0 to 255) E/N@@S(1)-type: None		

# CP1E-E@@(S)D@-@ CP1E-N@@(S@)D@-@/NA20D@-@

Item		CP1E-E@@SD@-@ CP1E-E@@D@-@	CP1E-N@@S@D@-@ CP1E-N@@D@-@ CP1E-NA@@D@-@	
Communications	B-type Peripheral USB Port	Conforming to USB 2.0 B type connector		
		Transmission distance	5 m max.	
	Built-in RS-232C port	No built-in RS-232C port	Interface: Conforms to EIA RS-232C.	
			Communications method	Half duplex
			synchronization	Start-stop
			Baud rate	1.2, 2.4, 4.8, 9.6, 19.2, 38.4, 57.6, or 115.2 kbps
			Transmission distance	15 m max.
		Supported protocol	<ul style="list-style-type: none"> <li>• Host Link</li> <li>• 1:N NT Link</li> <li>• No-protocol mode</li> <li>• Serial PLC Links (master, slave)</li> <li>• Modbus-RTU Easy Master</li> </ul>	
	Built-in RS-485 port	No built-in RS-485 port	N30/40/60S1-type only Interface: Conforms to EIA RS-485. 2-wire sensors No isolation	
			Communications method	Half duplex
	synchronization		Start-stop	
	Baud rate		1.2, 2.4, 4.8, 9.6, 19.2, 38.4, 57.6, or 115.2 kbps	
	Transmission distance		50 m max.	
	Supported protocol	<ul style="list-style-type: none"> <li>• Host Link</li> <li>• 1:N NT Link</li> <li>• No-protocol mode</li> <li>• Serial PLC Links (master, slave)</li> <li>• Modbus-RTU Easy Master</li> </ul>		
Serial Option port	Option Board cannot be mounted.	N30/40/60 and NA20-type only 1 port		
		Mountable Option Boards	<ul style="list-style-type: none"> <li>• One RS-232C port: CP1W-CIF01</li> <li>• One RS-422A/485 port (not isolated): CP1W-CIF11</li> <li>• One RS-422A/485 port (isolated): CP1W-CIF12-V1</li> <li>• One Ethernet port: CP1W-CIF41</li> </ul>	
		Communications method	Depends on Option Board.	
		synchronization	Depends on Option Board.	
		Baud rate	1.2, 2.4, 4.8, 9.6, 19.2, 38.4, 57.6, or 115.2 kbps	
	Compatible protocols	<ul style="list-style-type: none"> <li>• Host Link</li> <li>• 1:N NT Link</li> <li>• No-protocol mode</li> <li>• Serial PLC Links (master, slave)</li> <li>• Modbus-RTU Easy Master</li> </ul>		
Number of tasks	17 <ul style="list-style-type: none"> <li>• One cyclic execution task</li> <li>• One scheduled interrupt task (always interrupt task 1)</li> <li>• Six input interrupt tasks (interrupt tasks 2 to 7)</li> <li>• Sixteen high-speed counter interrupt tasks (interrupt tasks 1 to 16)</li> </ul>			
Maximum subroutine number	128			
Maximum jump number	128			
Scheduled interrupt tasks	1 interrupt task			
Clock	Clock function not included. The time of error occurrence displays 01-01-01 01:01:01 Sunday		Included. Accuracy (monthly deviation): -4.5 min to -0.5 min at ambient temperature of 55°C, -2.0 min to +2.0 min at ambient temperature of 25°C, -2.5 min to +1.5 min at ambient temperature of 0°C	
Memory backup	Built-in EEPROM	Ladder programs and parameters are automatically saved to built-in EEPROM A section of the Data Memory Area can be saved to the built-in EEPROM.		
	Battery backup With CP1W-BAT01 Battery (Sold separately)	Battery cannot be mounted.	CP1W-BAT01 can be used. Maximum battery service life: 5 years Backup Time Guaranteed value (ambient temperature: 55°C): 13,000 hours (approx. 1.5 years) Effective value (ambient temperature: 25°C): 43,000 hours (approx. 5 years)	
CIO Area	Input Bits	1,600 bits (100 words): CIO 0.00 to CIO 99.15 (CIO 00 to CIO 99)		
	Output Bits	1,600 bits (100 words): CIO 100.00 to CIO 199.15 (CIO 100 to CIO 199)		
	Serial PLC Link Words	1,440 bits (90 words): CIO 200.00 to CIO 289.15 (words CIO 200 to CIO 289)		
Work Area (W)	1,600 bits (100 words): W0.00 to W99.15 (W0 to W99)			
Holding Area (H)	800 bits (50 words): H0.00 to H49.15 (H0 to H49) Bits in this area maintain their ON/OFF status when operating mode is changed.			
Auxiliary Area (A)	Read-only: 7,168 bits (448 words) A0 to A447 Read/write: 4,896 bits (306 words) in words A448 to A753			
Temporary Relay Area (TR) (TR Area)	16 bits: TR0 to TR15			
Timer Area (T)	256 timer numbers (T0 to T255 (separate from counters))			
Counter Area (C)	256 counter numbers (C0 to C255 (separate from timers))			



# CP1E-E@@(S)D@-@ CP1E-N@@(S@)D@-@/NA20D@-@

Item	CP1E-E@@SD@-@ CP1E-E@@D@-@	CP1E-N@@S@D@-@ CP1E-N@@D@-@ CP1E-NA@@D@-@
<b>Data Memory Area (D)</b>	2 Kwords: D0 to D2047 Of these, 1,500 words can be saved to the backup memory (built-in EEPROM) using settings in the Auxiliary Area.	8 Kwords: D0 to D8191 Of these, 7,000 words can be saved to the backup memory (built-in EEP-ROM) using settings in the Auxiliary Area
<b>Operating modes</b>	PROGRAM mode: Program execution is stopped. Preparations can be executed prior to program execution in this mode. MONITOR mode: Programs are executed. Some operations, such as online editing, and changes to present values in I/O memory, are enabled in this mode. RUN mode: Programs are executed. This is the normal operating mode.	

## Internal Memory in the CPU Units

### CPU Unit Memory Backup Structure

The internal memory in the CPU Unit consists of built-in RAM and built-in EEPROM. The built-in RAM is used as execution memory and the built-in EEPROM is used as backup memory.

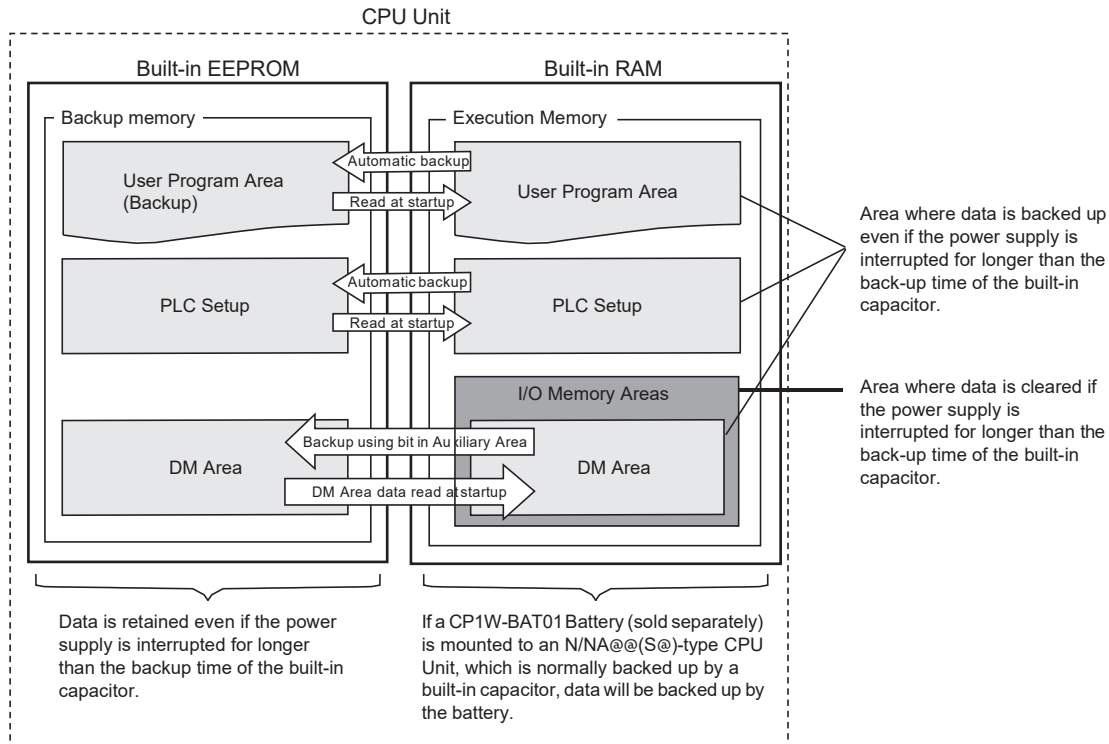

### ● Precautions for Correct Use

Create a system and write the ladder programs so that problems will not occur in the system if the data in these area may be unstable.

- Data in areas such as the DM area (D), Holding Area (H), the Counter Present Values (C) and the status of Counter Completion Flags (C), which is retained by the battery, may be unstable when the power supply is turned off (Except for the DM area that are retained by the built-in EEPROM using the Auxiliary Area bit.)
- The error log, and clock data (N/NA@@(S@)-type CPU Unit only) in the Auxiliary Area will become unstable. Other words and bits in the Auxiliary Area will be cleared to their default values.

The built-in capacitor's backup time varies with the ambient temperature as shown in the following graph.

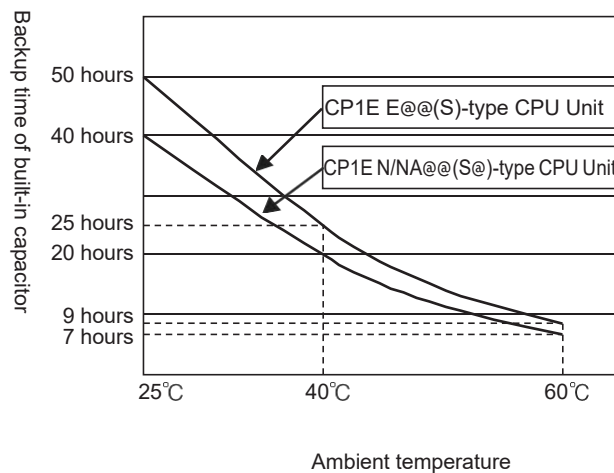

## I/O Memory Areas

Data can be read and written to I/O memory from the ladder programs. I/O memory consists of an area for I/O with external devices, user areas, and system areas.

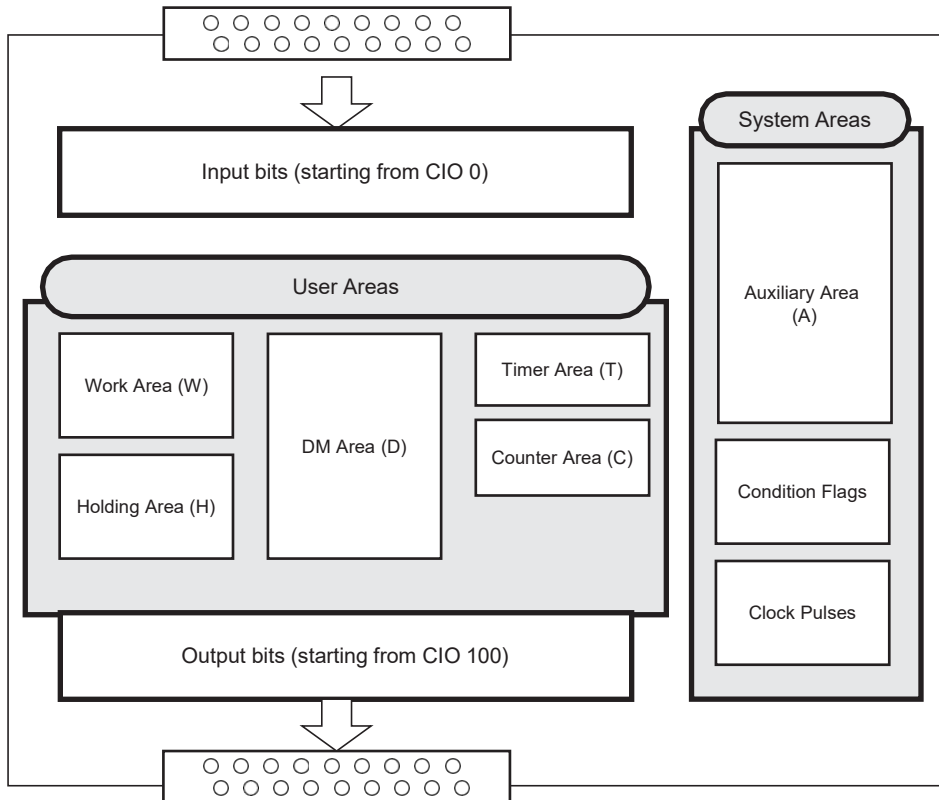

## I/O Memory Areas

Name		No. of bits	Word addresses	Remarks
CIO Area	Input Bits	1,600 bits (100 words)	CIO 0 to CIO 99	For NA-type, CIO90, CIO91 is occupied by analog input 0, 1.
	Output Bits	1,600 bits (100 words)	CIO 100 to CIO 199	For NA-type, CIO190 is occupied by analog output 0.
	Serial PLC Link Words	1,440 bits (90 words)	CIO 200 to CIO 289	--
Work Area (W)		1,600 bits (100 words)	W0 to W99	--
Holding Area (H)		800 bits (50 words)	H0 to H49	Data in this area is retained during power interruptions if a Battery Set (sold separately) is mounted to an N/NA@@(S@)-type CPU Unit.
Data Memory Area (D)	E@@(S)-type CPU Unit	2K words	D0 to D2047	Data in specified words of the DM Area can be retained in the built-in EEPROM in the backup memory by using a bit in the Auxiliary Area. Applicable words: D0 to D1499 (One word can be specified at a time.)
	N/NA@@(S@)-type CPU Unit	8K words	D0 to D8191	Data in specified words of the DM Area can be retained in the built-in EEPROM in the backup memory by using a bit in the Auxiliary Area. Applicable words: D0 to D6999 (One word can be specified at a time.)
Timer Area (T)	Present values	256	T0 to T255	--
	Timer Completion Flags	256		--
Counter Area (C)	Present values	256	C0 to C255	Data in this area is retained during power interruptions if a Battery Set (sold separately) is mounted to an N/NA@@(S@)-type CPU Unit.
	Counter Completion Flags	256		--
Auxiliary Area (A)	Read only	7168 bits (448 words)	A0 to A447	Data in this area is retained during power interruptions if a Battery Set (sold separately) is mounted to an N/NA@@(S@)-type CPU Unit.
	Read-write	4,896 bits (306 words)	A448 to A753	

## Backing Up and Restoring DM Area Data

The contents of the DM Area (D) will become unstable if the power supply is interrupted for longer than the backup time of the built-in capacitor (50 hours for an E@@(S)-type CPU Unit, 40 hours for an N/NA@@(S@)-type CPU Unit without a Battery). The contents of the specified words in the DM Area data can be backed up from RAM to the built-in EEPROM backup memory during operation by turning ON a bit in the Auxiliary Area. The number of DM Area words to back up is specified in the Number of CH of DM for backup Box in the PLC Setup. If the Restore D0- from backup memory Check Box is selected in the PLC Setup, the backup data will automatically be restored to RAM when the power is turned back ON so that data is not lost even if power is interrupted.

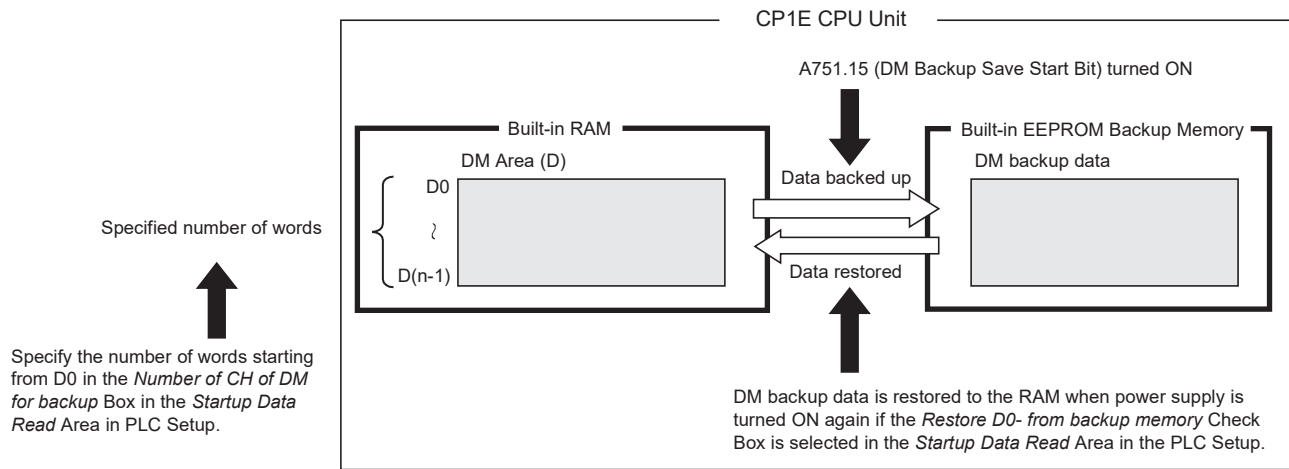

### Conditions for Executing Backup

Specified words starting from D0 in the RAM can be saved to the built-in EEPROM backup memory by turning ON A751.15. (These words are called the DM backup words and the data is called the DM backup data.) A751.15 (DM Backup Save Start Bit) can be used in any operating mode (RUN, MONITOR, or PROGRAM mode).

### Words That Can Be Backed Up

- E@@(S)-type CP1E CPU Units: D0 to D1499
- N/NA@@(S@)-type CP1E CPU Units: D0 to D6999

### Number of Words To Back Up

The number of words to back up starting from D0 is set in the *Number of CH of DM for backup* Box in the *Startup Data Read Area* in the PLC Setup.

### Restoring DM Backup Data to RAM When Power Is Turned ON

The DM backup data can be restored to RAM when power is turned ON by selecting the *Restore D0- from backup memory* Check Box in the *Startup Data Read Area* in the PLC Setup. The DM backup data will be read from the backup memory even if the *Clear retained memory area (HR/DM/CNT)* Check Box is selected in the PLC Setup.

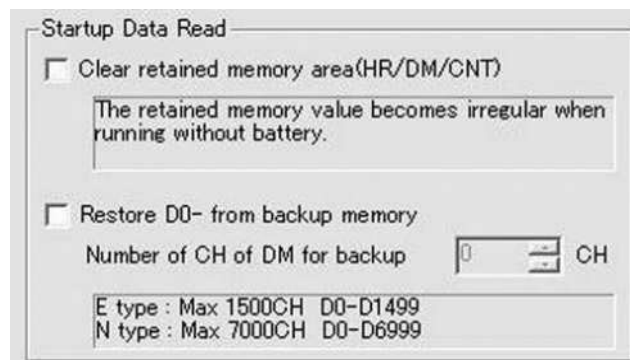

## Built-in Inputs

### Terminal Arrangements

#### ● Input Terminal Arrangement for CPU Unit with 10 I/O Points

AC power supply models

CIO 0					
L1	L2/N	COM	01	03	05
NC		00	02	04	

DC power supply models

CIO 0					
+	-	COM	01	03	05
NC		00	02	04	

#### ● Input Terminal Arrangement for CPU Unit with 14 I/O Points

AC power supply models

CIO 0									
L1	L2/N	COM	01	03	05	07	NC	NC	
NC		00	02	04	06	NC	NC		

DC power supply models

CIO 0									
+	-	COM	01	03	05	07	NC	NC	
NC		00	02	04	06	NC	NC		

#### ● Input Terminal Arrangement for CPU Unit with 20 I/O Points

AC power supply models

CIO 0											
L1	L2/N	COM	01	03	05	07	09	11			
NC		00	02	04	06	08	10				

DC power supply models

CIO 0											
+	-	COM	01	03	05	07	09	11			
NC		00	02	04	06	08	10				

#### ● Input Terminal Arrangement for CPU Unit with 30 I/O Points

AC power supply models

CIO 0											CIO 1			
L1	L2/N	COM	01	03	05	07	09	11	01	03	05			
		00	02	04	06	08	10	00	02	04	NC			

DC power supply models

CIO 0											CIO 1			
+	-	COM	01	03	05	07	09	11	01	03	05			
NC		00	02	04	06	08	10	00	02	04	NC			

● Input Terminal Arrangement for CPU Unit with 40 I/O Points

AC power supply models

CIO 0										CIO 1					
L1	L2/N	COM	01	03	05	07	09	11	01	03	05	07	09	11	
			00	02	04	06	08	10	00	02	04	06	08	10	

DC power supply models

CIO 0										CIO 1					
+	-	COM	01	03	05	07	09	11	01	03	05	07	09	11	
NC			00	02	04	06	08	10	00	02	04	06	08	10	

● Input Terminal Arrangement for CPU Unit with 60 I/O Points

AC power supply models

CIO 0										CIO 1						CIO 2					
L1	L2/N	COM	01	03	05	07	09	11	01	03	05	07	09	11	01	03	05	07	09	11	
			00	02	04	06	08	10	00	02	04	06	08	10	00	02	04	06	08	10	

DC power supply models

CIO 0										CIO 1						CIO 2					
+	-	COM	01	03	05	07	09	11	01	03	05	07	09	11	01	03	05	07	09	11	
NC			00	02	04	06	08	10	00	02	04	06	08	10	00	02	04	06	08	10	

● Input Terminal Arrangement for CPU Unit with 20 I/O Points and Built-in Analog

AC power supply models

CIO 0										CIO 90		CIO 91	
L1	L2/N	COM	01	03	05	07	09	11	I IN0	AG	I IN1		
			00	02	04	06	08	10	V IN0	COM0	V IN1	COM1	

DC power supply models

CIO 0										CIO 90		CIO 91	
+	-	COM	01	03	05	07	09	11	I IN0	AG	I IN1		
NC			00	02	04	06	08	10	V IN0	COM0	V IN1	COM1	

### Allocating Built-in Inputs to Functions

Input terminals are allocated functions by setting parameters in the PLC Setup. Set the PLC Setup so that each terminal is used for only one function.

CPU Unit with I/O Points	Input terminal block		Settings in PLC Setup							
			Interrupt input setting on Built-in Input Tab Page			High-speed counter 0 to 3 setting on Built-in Input Tab Page			Origin search settings on Pulse Output 0/1 Tab Page	
	Terminal block label	Terminal number	Normal	Interrupt	Quick	Single-phase (increment pulse input)	Two-phase (differential phase x4 or up/down)	Two-phase (pulse/direction)	CPU Unit with 20 to 60 points	CPU Unit with 14 I/O points
10	CIO 0	00	Normal input 0	--	--					
		01	Normal input 1	--	--	Counter 1, increment input	Counter 0, phase B or down input	Counter 1, pulse input	--	--
		02	Normal input 2	Interrupt input 2	Quick-response input 2	Counter 2, increment input	Counter 1, phase A or up input	Counter 0, direction	--	--
		03	Normal input 3	Interrupt input 3	Quick-response input 3	--	Counter 1, phase B or down input	Counter 1, direction	--	Pulse 0, Origin proximity input signal
		04	Normal input 4	Interrupt input 4	Quick-response input 4	Counter 3, increment input	Counter 0, phase Z or reset input	Counter 0, reset input	--	--
		05	Normal input 5	Interrupt input 5	Quick-response input 5	Counter 4, increment input	Counter 1, phase Z or reset input	Counter 1, reset input	--	Pulse 1, Origin proximity input signal
		06	Normal input 6	Interrupt input 6	Quick-response input 6	Counter 5, increment input	--	--	Pulse 0: Origin input signal	Pulse 0, Origin input signal
		07	Normal input 7	Interrupt input 7	Quick-response input 7	--	--	--	Pulse 1: Origin input signal	Pulse 1, Origin input signal
		08	Normal input 8	--	--	--	--	--	--	--
		09	Normal input 9	--	--	--	--	--	--	--
		10	Normal input 10	--	--	--	--	--	Pulse 0: Origin proximity input signal	--
		11	Normal input 11	--	--	--	--	--	Pulse 1: Origin proximity input signal	--
30	CIO 1	00 to 05	Normal input 12 to 17	--	--	--	--	--	--	
40		06 to 11	Normal input 18 to 23	--	--	--	--	--	--	
60	CIO 2	00 to 11	Normal input 24 to 35	--	--	--	--	--	--	

These functions are supported only by N/NA@@(S@)-type CPU Units with transistor outputs.

## Built-in Outputs

### Terminal Arrangements

#### ● Output Terminal Arrangement for CPU Unit with 10 I/O Points

AC power supply model

DC power supply model

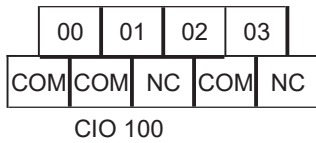

#### ● Output Terminal Arrangement for CPU Unit with 14 I/O Points

AC power supply model

DC power supply model

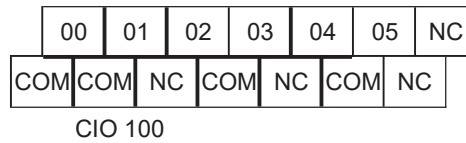

#### ● Output Terminal Arrangement for CPU Unit with 20 I/O Points

AC power supply model

DC power supply model

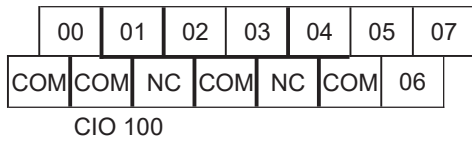

#### ● Output Terminal Arrangement for CPU Unit with 30 I/O Points

AC power supply model

E/N30(S@)D@-A

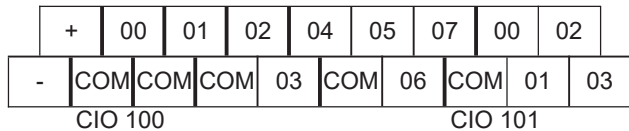

DC power supply model

N30D@-D

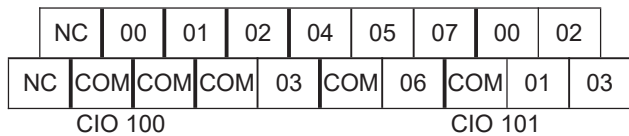

N30S(1)DT-D

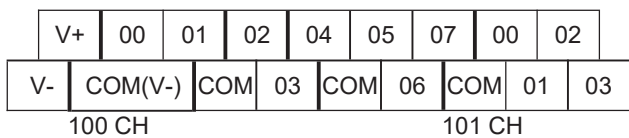

Note: V- and COM(V-) are internally connected.

N30S(1)DT1-D

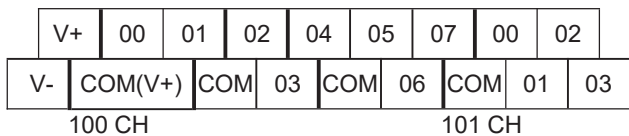

Note: V+ and COM(V+) are internally connected.



● Output Terminal Arrangement for CPU Unit with 40 I/O Points

AC power supply model

E/N40(S@)D@-A

+	00	01	02	03	04	06	00	01	03	04	06
-	COM	COM	COM	COM	05	07	COM	02	COM	05	07
CIO 100						CIO 101					

DC power supply model

N40D@-D

NC	00	01	02	03	04	06	00	01	03	04	06
NC	COM	COM	COM	COM	05	07	COM	02	COM	05	07
CIO 100						CIO 101					

N40S(1)DT-D

V+	00	01	02	03	04	06	00	01	03	04	06
V-	COM(V-)	COM	COM	05	07	COM	02	COM	05	07	
100 CH						101 CH					

Note: V- and COM(V-) are internally connected.

N40S(1)DT1-D

V+	00	01	02	03	04	06	00	01	03	04	06
V-	COM(V+)	COM	COM	05	07	COM	02	COM	05	07	
100 CH						101 CH					

Note: V+ and COM(V+) are internally connected.

● Output Terminal Arrangement for CPU Unit with 60 I/O Points

AC power supply model

E/N60(S@)D@-A

+	00	01	02	04	05	07	00	02	04	05	07	00	02	04	05	07	
-	COM	COM	COM	03	COM	06	COM	01	03	COM	06	COM	01	03	COM	06	
CIO 100						CIO 101						CIO 102					

DC power supply model

N60D@-D

NC	00	01	02	04	05	07	00	02	04	05	07	00	02	04	05	07	
NC	COM	COM	COM	03	COM	06	COM	01	03	COM	06	COM	01	03	COM	06	
CIO 100						CIO 101						CIO 102					

N60S(1)DT-D

V+	00	01	02	04	05	07	00	02	04	05	07	00	02	04	05	07	
V-	COM(V-)	COM	03	COM	06	COM	01	03	COM	06	COM	01	03	COM	06		
100 CH						101 CH						102 CH					

Note: V- and COM(V-) are internally connected.

N60S(1)DT1-D

V+	00	01	02	04	05	07	00	02	04	05	07	00	02	04	05	07	
V-	COM(V+)	COM	03	COM	06	COM	01	03	COM	06	COM	01	03	COM	06		
100 CH						101 CH						102 CH					

Note: V+ and COM(V+) are internally connected.

# CP1E-E@@(S)D@-@ CP1E-N@@(S@)D@-@/NA20D@-@

## ● Output Terminal Arrangement for CPU Unit with 20 I/O Points and Built-in Analog

AC power supply model

DC power supply model

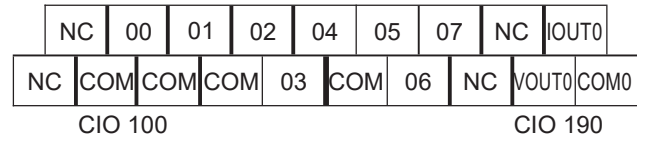
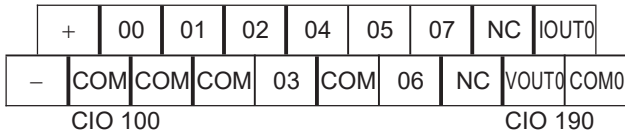

## Allocating Built-in Output Terminals to Functions

Output terminals are allocated functions by setting parameters in the PLC Setup. Set the PLC Setup so that each terminal is used for only one function.

CPU Unit with I/O points	Output terminal block		Other than those shown right	When a pulse output instruction (SPED, ACC, PLS2, or ORG) is executed	Setting in PLC Setup		When the PWM instruction is executed
	Terminal block label	Terminal number			Normal output	Origin search setting on Pulse Output 0/1 Tab Page	
			Fixed duty ratio pulse output			Variable duty ratio pulse output	
				Pulse + direction	Use	PWM output	
10	CIO 100	00	Normal output 0	Pulse output 0 (pulse)	--	--	
		01	Normal output 1	Pulse output 1 (pulse)	--	PWM output 0	
		02	Normal output 2	Pulse output 0 (direction)	--	--	
		03	Normal output 3	Pulse output 1 (direction)	--	--	
		04	Normal output 4	--	Pulse 0: Error counter reset output	--	
		05	Normal output 5	--	Pulse 1: Error counter reset output	--	
		06	Normal output 6	--	--	--	
14	CIO 101	07	Normal output 7	--	--	--	
		00 to 03	Normal output 8 to 11	--	--	--	
20	CIO 101	04 to 07	Normal output 12 to 15	--	--	--	
		00 to 07	Normal output 16 to 23	--	--	--	
30	CIO 102						
40							
60							

These functions are supported only by N/NA@@(S@)-type CPU Units with transistor outputs.

# I/O Specifications for CPU Units

## Input Specifications

Item	Specification		
Input type	High-speed counter inputs or Normal Inputs	High-speed counter inputs, interrupt input, quick-response inputs, or Normal Inputs	Normal inputs
Input bits	CIO 0.00 to CIO 0.01	CIO 0.02 to CIO 0.07 *1	CIO 0.08 to CIO 0.11, CIO 1.00 to CIO 1.11 and CIO 2.00 to CIO 2.11 *1
Input voltage	24 VDC, +10%, -15%		
Applicable sensors	2-wire and 3-wire sensors		
Input impedance	3.3 kΩ	3.3 kΩ	4.8 kΩ
Input current	7.5 mA typical	7.5 mA typical	5 mA typical
ON voltage/current	3 mA min. at 17.0 VDC min.	3 mA min. at 17.0 VDC min.	3 mA min. at 14.4 VDC min.
OFF voltage/current	1 mA max. at 5.0 VDC max.	1 mA max. at 5.0 VDC max.	1 mA max. at 5.0 VDC max.
ON response time *2	E@@(S)-type CPU Unit: 50 μs min. N/NA@@(S@)-type CPU Unit: 2.5 μs min.	50 μs max.	1 ms max.
OFF response time *2	E@@(S)-type CPU Unit: 50 μs min. N/NA@@(S@)-type CPU Unit: 2.5 μs min.	50 μs max.	1 ms max.

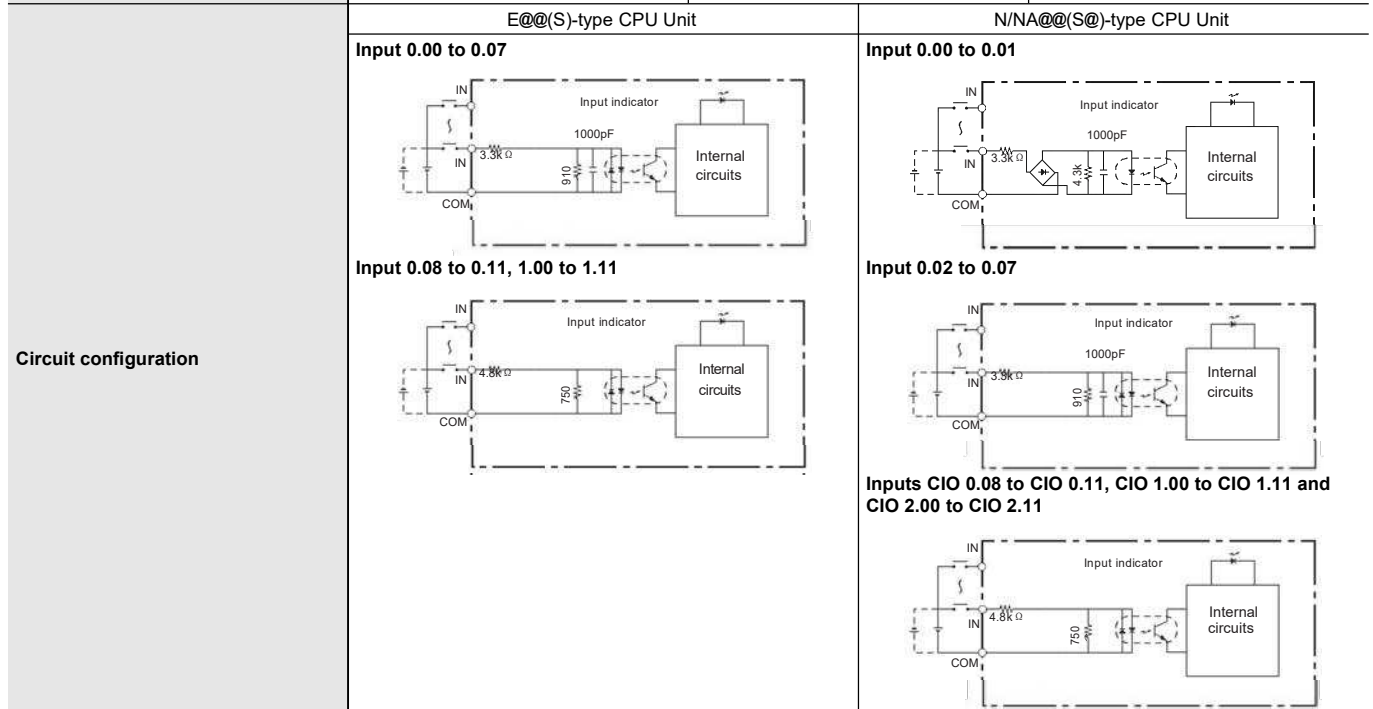

\* 1 The bits that can be used depend on the model of CPU Unit.

\* 2 The response time is the delay caused by hardware. The delay set in the PLC Setup (0 to 32 ms, default: 8 ms) for a normal input must be added to this value.

Pulse plus direction input mode,  
Increment mode  
Up/down input mode

Differential phase mode

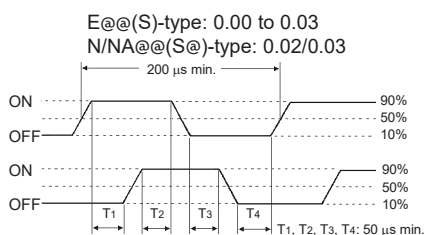
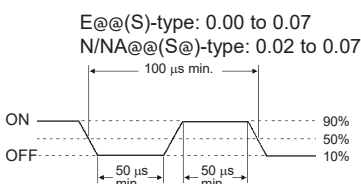
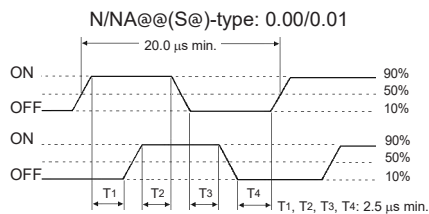
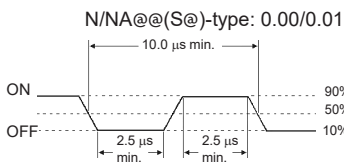

## Output Specifications

### ● Output Specifications for Relay Outputs

Item	Specification		
Maximum switching capacity	250 VAC/2 A ( $\cos\phi = 1$ ) 2 A, 24 VDC (4 A/common)		
Minimum switching capacity	5 VDC, 10 mA		
Service life of relay	Electrical	Resistive load	200,000 operations (24 VDC)
		Inductive load	70,000 operations (250 VAC, $\cos\phi = 0.4$ )
	Mechanical	20,000,000 operations	
ON delay	15 ms max.		
OFF response time	15 ms max.		
Circuit configuration			

### Estimating the Service Life of Relays

Under normal conditions, the service life of output contacts is as shown above. The service life of relays is as shown in the following diagram as a guideline

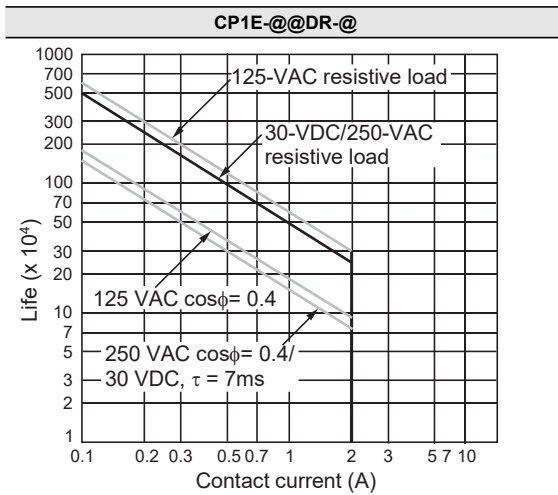

### Relationship between Continuous Simultaneous ON Rate and Ambient Temperature

There are restrictions on the power supply voltage and output load current imposed by the ambient temperature. Make sure that the power supply voltage and output load current are within the following ranges.

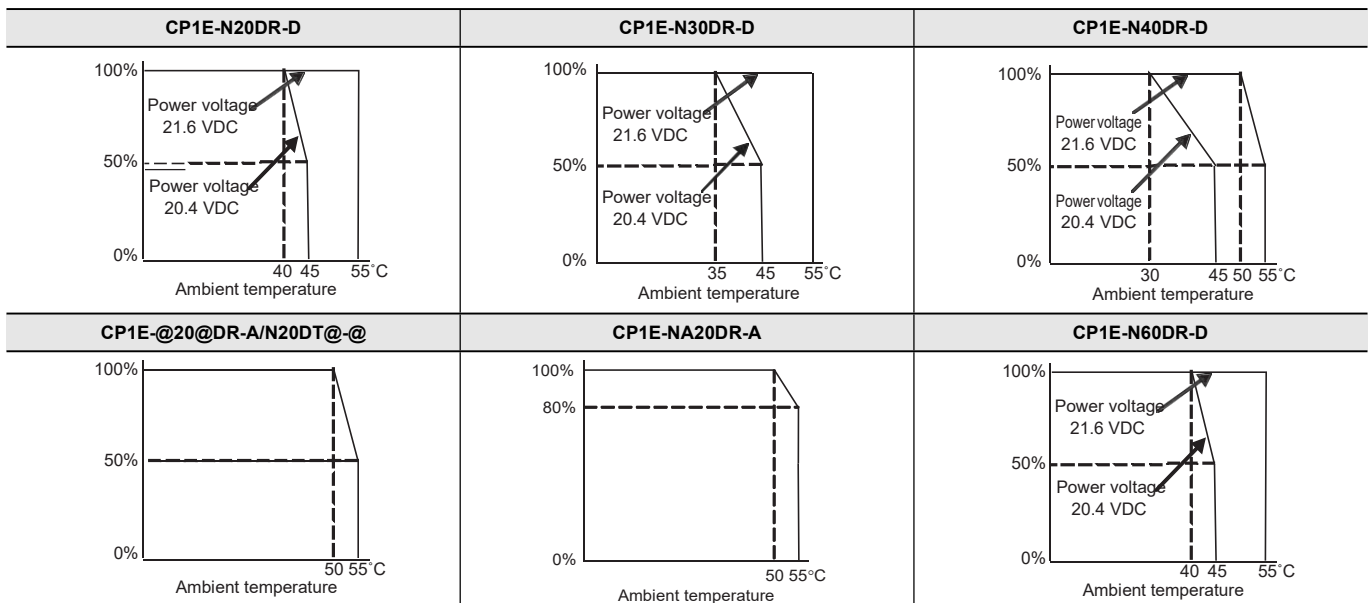

**Note:** The above restrictions apply to the relay output load current from the CPU Unit even if Expansion I/O Units are not connected.

● Output Specifications for Transistor Outputs (Sinking or Sourcing)

Normal Outputs

Item	Specification		
	N@@(S@)-type 100.00, 100.01		N@@(S@)-type 100.02 to 102.07 *2 E10-type 100.00 to 100.03
	N@@S(1)-type	N@@-type	
Maximum switching capacity	0.3 A/output, 0.9 A/common *1 4.5 to 30 VDC CP1E-E10D@-@: 0.9 A/Unit CP1E-N40(S@)D@-@: 3.6 A/Unit CP1E-N14D@-@: 1.5 A/Unit CP1E-N60(S@)D@-@: 5.4 A/Unit CP1E-N20D@-@: 1.8 A/Unit CP1E-NA20D@-@: 1.8 A/Unit CP1E-N30(S@)D@-@: 2.7 A/Unit		
Minimum switching capacity	1 mA 4.5 to 30 VDC		
Leakage current	0.1mA max.		
Residual voltage	0.6 V max.		1.5V max.
ON response time	0.1 ms max.		0.1 ms max.
OFF response time	0.1 ms max.		1 ms max.
Fuse	Not provided.		
External Power Supply	20.4 to 26.4V VDC 30mA max.	None	None

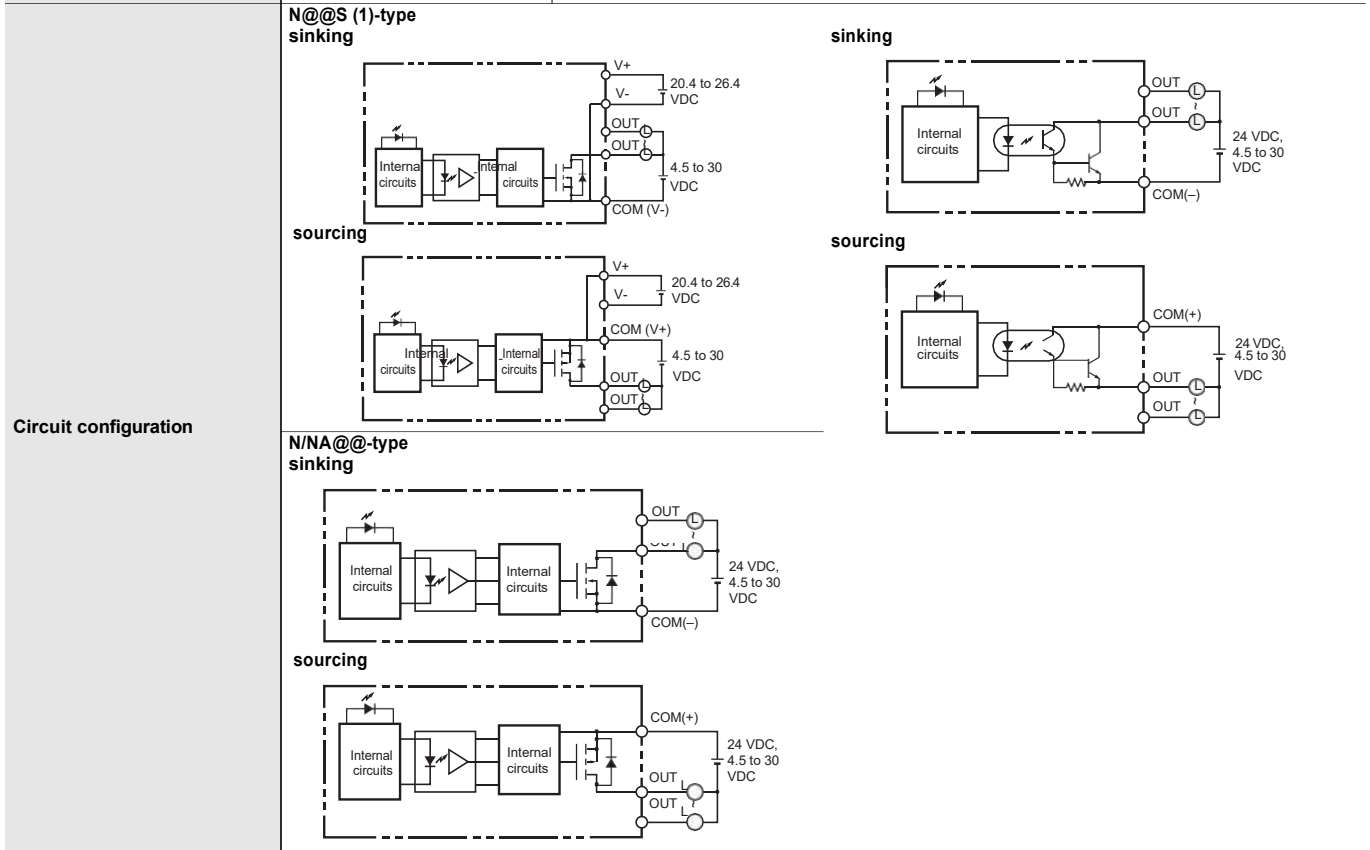

**Note:** Do not connect a load to an output terminal or apply a voltage in excess of the maximum switching capacity.

\* **1** Also do not exceed 0.9 A for the total for CIO 100.00 to CIO 100.03. (CIO 100.00 to CIO 100.03 is different common.)

\* **2** The bits that can be used depend on the model of CPU Unit.

Pulse Outputs (CIO 100.00 and CIO 100.01)

Item	Specification
Maximum switching capacity	100 mA/4.5 to 26.4 VDC
Minimum switching capacity	7 mA/4.5 to 26.4 VDC
Maximum output frequency	100 kHz
Output waveform	<p>The diagram shows a pulse waveform with a high level labeled 'OFF 90%' and a low level labeled 'ON 10%'. The rise and fall times are indicated as 4µs min. and 2µs min. respectively.</p>

- Note:**
- The load for the above values is assumed to be the resistance load, and does not take into account the impedance for the connecting cable to the load.
  - Due to distortions in pulse waveforms resulting from connecting cable impedance, the pulse widths in actual operation may be smaller than the values shown above.
  - The OFF and ON refer to the output transistor. The output transistor is ON at level "L".

**PWM Output (CIO 100.01)**

Item	Specification
Maximum switching capacity	30 mA/4.5 to 26.4 VDC
Maximum output frequency	32 kHz
PWM output accuracy	For ON duty +1%, .0%:10 kHz output For ON duty +5%, .0%: 0 to 32 kHz output
Output waveform	<p style="text-align: center;">ON duty = <math>\frac{t_{ON}}{T} \times 100\%</math></p>

**Note:** The OFF and ON refer to the output transistor. The output transistor is ON at level "L".

**Built-in Analog I/O (NA-type CPU Units)**

● **Analog Input Specifications**

Item	Voltage input	Current input
Number of inputs	2 inputs (Allocated 2 words: CIO 90 to CIO 91.)	
Input signal range	0 to 5 V, 1 to 5 V, 0 to 10 V, or -10 to 10 V	0 to 20 mA or 4 to 20 mA
Max. rated input	±15 V	±30 mA
External input impedance	1 MΩ min.	Approx. 250 Ω
Resolution	1/6000	
Overall accuracy	At 25°C	±0.3% full scale
	0 to 55°C	±0.6% full scale
A/D conversion data	-10 to +10 V	F448 to 0BB8 hex Full Scale
	Other ranges	0000 to 1770 hex Full Scale
Averaging function	Supported (Set for individual inputs in the PLC Setup.)	
Open-circuit detection function	Supported (Value when disconnected: 8000 hex)	

● **Analog Output Specifications**

Item	Voltage output	Current output
Number of outputs	1 output (Allocated 1 word: CIO 190.)	
Output signal range	0 to 5 V, 1 to 5 V, 0 to 10 V, or -10 to 10 V	0 to 20 mA or 4 to 20 mA
Allowable external output load resistance	1 kΩ min.	600 Ω max.
External input impedance	0.5 Ω max.	---
Resolution	1/6000	
Overall accuracy	At 25°C	±0.4% full scale *
	0 to 55°C	±0.8% full scale *
D/A conversion data	-10 to +10 V	F448 to 0BB8 hex Full Scale
	Other ranges	0000 to 1770 hex Full Scale

\* In 0 to 20 mA mode, accuracy cannot be ensured at 0.2 mA or less.

● **Shared I/O Specifications**

Item	Specification
Conversion time	2 ms/point (6 ms total for 2 analog inputs and 1 analog output.)
Isolation method	Photocoupler isolation between analog I/O terminals and internal circuits. No isolation between analog I/O signals.

## Specifications of Expansion I/O Units and Expansion Units

### Expandable CPU Units

- Expansion I/O Units and Expansion Units cannot be connected to E10/14/20(S) or N14/20 CPU Units.
- A total of up to three Expansion I/O Units and Expansion Units can be connected to an E30/40/60(S), N30/40/60(S@), NA20 CPU Unit.

#### ● CP1E E10/14/20(S) or N14/20CPU Unit

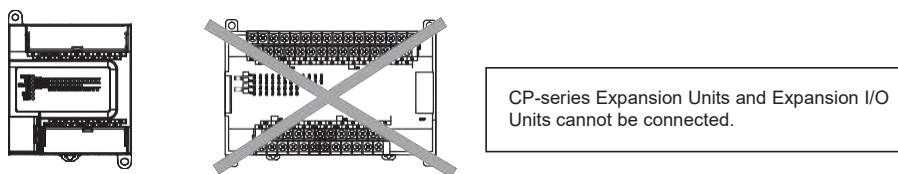

#### ● CP1E E30/40(S), N30/40/60(S@) or NA20 CPU Unit

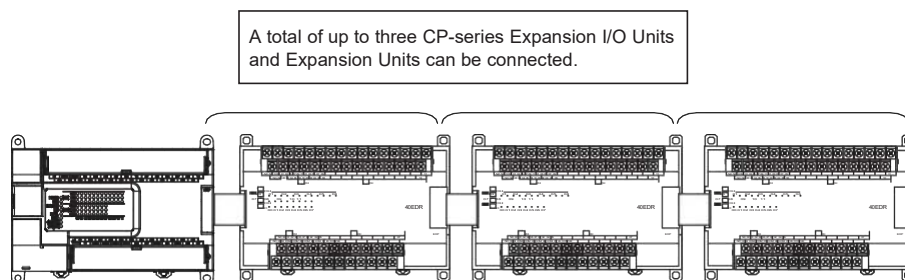

### Connection Methods

Connection cables for the Expansion I/O Units and Expansion Units are used to connect the Units. The length can be extended by using a CP1W-CN811 I/O Connection Cable (length: 800 m).

### Maximum Number of I/O Points for an Expanded System

CPU Unit	Built-in I/O on CPU Unit			Built-in Analog		Total number of Expansion I/O Units and Expansion Units that can be connected	Number of inputs: 24 Number of outputs: 16 Total number of I/O points when three CP1W-40ED@ Expansion I/O Units are connected		
	Total	Number of inputs	Number of outputs	AD	DA		Total	Number of inputs	Number of outputs
CP1E-E10D@-@	10	6	4	None	None	Not possible.	10	6	4
CP1E-@14@D@-@	14	8	6				14	8	6
CP1E-@20@D@-@	20	12	8				20	12	8
CP1E-@30@D@-@	30	18	12			3 Units maximum	150	90	60
CP1E-@40@D@-@	40	24	16				160	96	64
CP1E-@60@D@-@	60	36	24				180	108	72
CP1E-NA20D@-@	20	12	8	2	1	140	84	56	

### Restrictions on External Power Supply Capacity

The following restrictions apply when using the CPU Unit's external power supply.

#### ● AC-power-supply E30/40(S), N30/40/60(S@) or NA20 CPU Unit

The power supply capacity is restricted for AC-power-supply E30/40/60(S), N30/40/60(S@), NA20 CPU Units. It may not be possible to use the full 300 mA of the external power supply, though a CPU Unit can connect any CP-series Expansion I/O Unit or Expansion Unit.

The entire 300 mA from the external power supply can be used if Expansion Units and Expansion I/O Units are not connected.

Refer to the CP1E CPU Unit Hardware Manual (Cat. No. W479) for details.

#### ● AC-power-supply or DC-power-supply E10/14/20(S), N14/20(S) CPU Unit

There is no external power supply on AC-power-supply or DC-power-supply E10/14/20, N14/20 CPU Units.

## Specifications of Expansion I/O Units

### ● Input Specifications (CP1W-40EDR/40EDT/40EDT1/20EDR1/20EDT/20EDT1/8ED)

Item	Specification
Input voltage	24 VDC +10%/-15%
Input impedance	4.7 k $\Omega$
Input current	5 mA typical
ON voltage	14.4 VDC min.
OFF voltage	5.0 VDC max.
ON delay	1 ms max. *
OFF delay	1 ms max. *

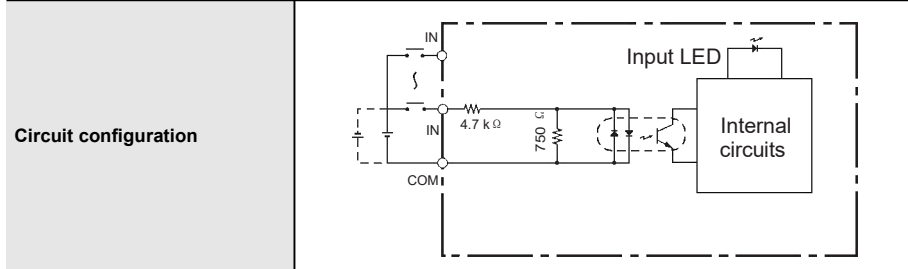

**Note:** Do not apply voltage in excess of the rated voltage to the input terminal.

\* The response time is the hardware delay value. The delay set in the PLC Setup (0 to 32 ms, default: 8 ms) must be added to this value. For the CP1W-40EDR/EDT/EDT1, a fixed value of 16 ms must be added.

### ● Output Specifications Relay Outputs (CP1W-40EDR/32ER/20EDR1/16ER/8ER)

Item	Specification
Max. switching capacity	2 A, 250 VAC ( $\cos\phi = 1$ ), 2 A, 24 VDC (4 A/common)
Min. switching capacity	5 VDC, 10 mA
Service life of relay (See note.)	Electrical Resistive load: 150,000 operations (24 VDC) Inductive load: 100,000 operations (240 VAC, $\cos\phi = 0.4$ )
	Mechanical: 20,000,000 operations
ON delay	15 ms max.
OFF delay	15 ms max.

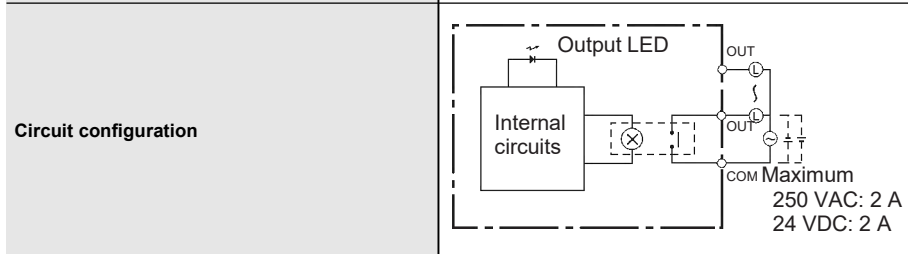

**Note:** Estimating the Service Life of Relays

The service life of output contacts is as shown in the following diagram.

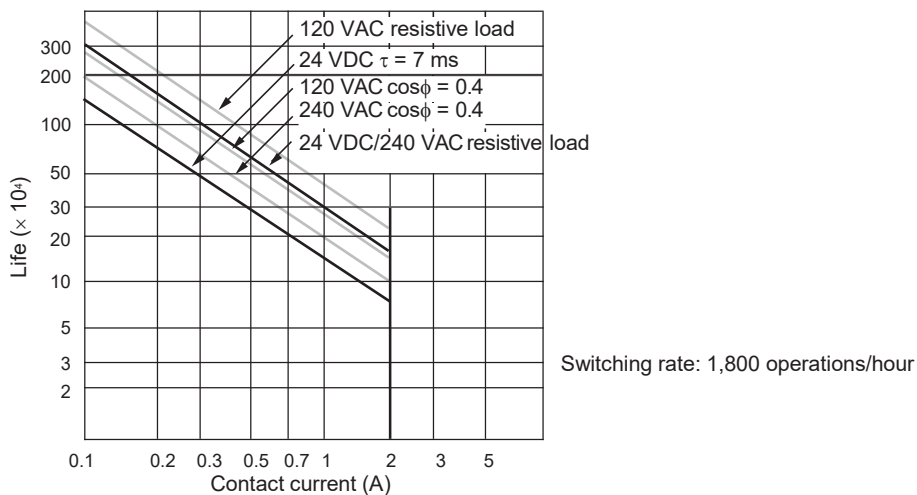



2. Restrictions of CP1W-16ER/32ER

Limit the output load current to satisfy the following derating curve.

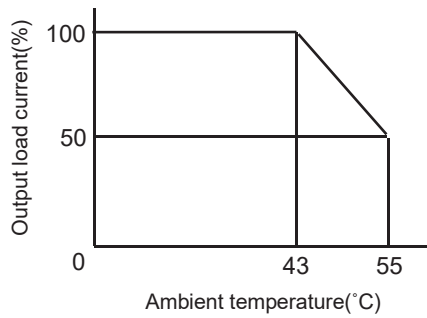

3. CP1W-32ER's maximum number of simultaneously ON output points is 24 (75%).  
Relation between Number of ON Outputs and Ambient Temperature (CP1W-32ER)

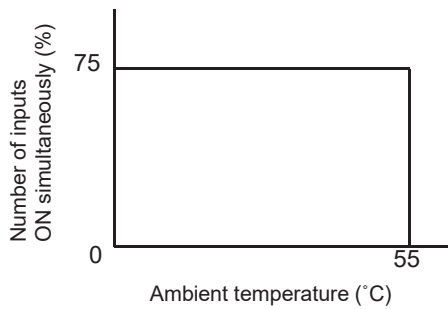

4. According to the ambient temperature, there are restrictions on power supply voltage and output load current for the CPU Units connected with the Expansion I/O Units (CP1W-8ER/16ER/20EDR1/32ER/40EDR). Use the PLC in the range of the power supply voltage and output load current as show below.  
The ambient temperature is restricted for the power-supply CPU Units (CP1E-N/NA@@@-@). Derating curve of the output load current for Expansion I/O Units (CP1W-8ER/16ER/20EDR1/32ER/40EDR).

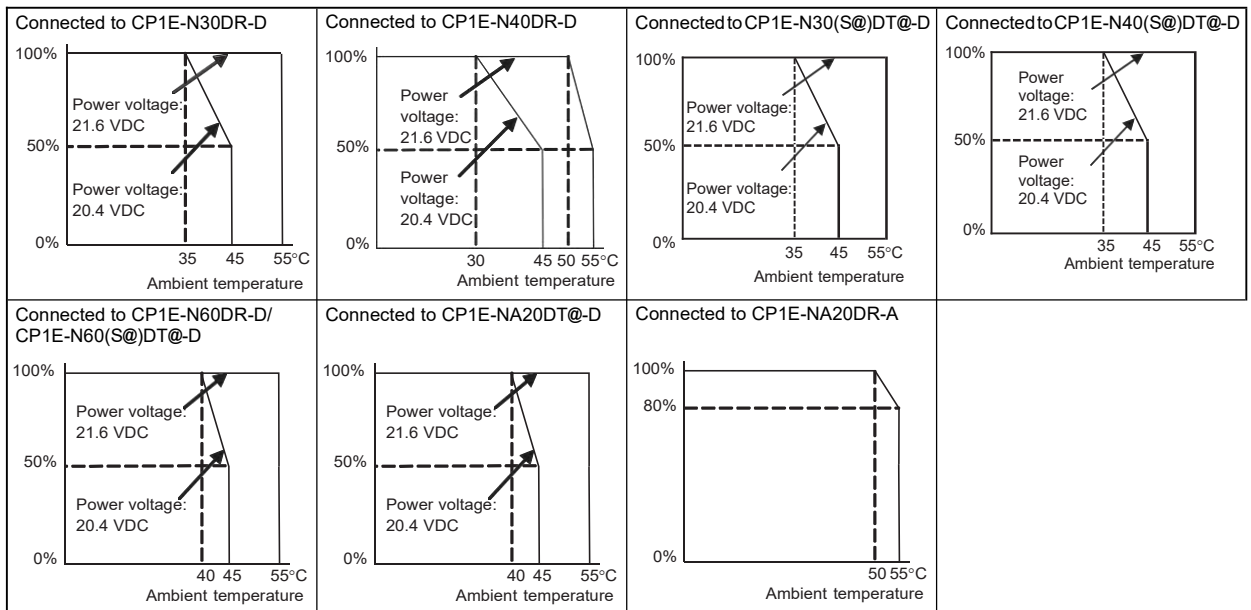

● Transistor Outputs (Sinking or Sourcing)

Item	Specification				
	CP1W-40EDT CP1W-40EDT1	CP1W-32ET CP1W-32ET1	CP1W-20EDT CP1W-20EDT1	CP1W-16ET CP1W-16ET1	CP1W-8ET CP1W-8ET1
<b>Max. switching capacity *1</b>	4.5 to 30 VDC 0.3 A/output 0.9 A/common 3.6 A/Unit	4.5 to 30 VDC 0.3 A/output 0.9 A/common 7.2 A/Unit	24 VDC +10%/-5% 0.3 A/output 0.9 A/common 1.8 A/Unit	4.5 to 30 VDC 0.3 A/output 0.9 A/common 3.6 A/Unit	4.5 to 30 VDC 0.3 A/output 0.9 A/common 1.8 A/Unit
<b>Leakage current</b>	0.1 mA max.	0.1 mA max.	0.1 mA max.	0.1 mA max.	0.1 mA max.
<b>Residual voltage</b>	1.5 V max.	1.5 V max.	1.5 V max.	1.5 V max.	1.5 V max.
<b>ON delay</b>	0.1 ms max.	0.1 ms max.	0.1 ms.	0.1 ms max.	0.1 ms max.
<b>OFF delay</b>	1 ms max. 24 VDC +10%/-5% 5 to 300 mA	1 ms max. 24 VDC +10%/-5% 5 to 300 mA	1 ms max. 24 VDC +10%/-5% 5 to 300 mA	1 ms max. 24 VDC +10%/-5% 5 to 300 mA	1 ms max. 24 VDC +10%/-5% 5 to 300 mA
<b>Max. number of Simultaneously ON Points of Output</b>	16 pts (100%)	24 pts (75%)	8 pts (100%)	16 pts (100%)	8 pts (100%)
<b>Fuse *2</b>	1 fuse/common				
<b>Circuit configuration</b>					

\*1 If the ambient temperature is maintained below 50°C, up to 0.9 A/common can be used.

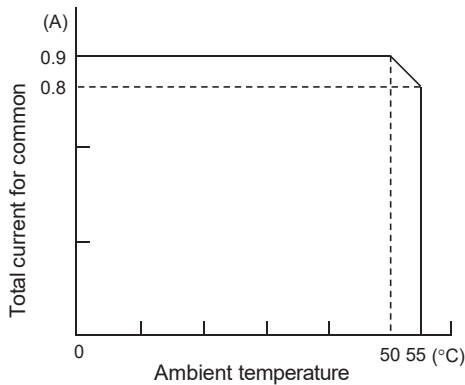

\*2 The fuse cannot be replaced by the user. Replace the Unit if the fuse breaks due to an short-circuit or overcurrent.

\*3 Do not connect a load to an output terminal or apply a voltage in excess of the maximum switching capacity.

## Specifications of Expansion Units

### ● Analog Input Units

Model		CP1W-AD041		CP1W-AD042	
Item		Voltage Input	Current Input	Voltage Input	Current Input
Number of inputs		4 inputs (4 words allocated)			
Input signal range		0 to 5 VDC, 1 to 5 VDC, 0 to 10 VDC, or -10 to 10 VDC	0 to 20 mA or 4 to 20 mA	0 to 5 VDC, 1 to 5 VDC, 0 to 10 VDC, or -10 to 10 VDC	0 to 20 mA or 4 to 20 mA
Max. rated input		±15 V	±30 mA	±15 V	±30 mA
External input impedance		1 M $\Omega$ min.	Approx. 250 $\Omega$	1 M $\Omega$ min.	Approx. 250 $\Omega$
Resolution		1/6000 (full scale)		1/12000 (full scale)	
Overall accuracy	25°C	0.3% full scale	0.4% full scale	0.2% full scale	0.3% full scale
	0 to 55°C	0.6% full scale	0.8% full scale	0.5% full scale	0.7% full scale
A/D conversion data		16-bit binary (4-digit hexadecimal) Full scale for -10 to 10 V: F448 to 0BB8 Hex Full scale for other ranges: 0000 to 1770 Hex		16-bit binary (4-digit hexadecimal) Full scale for -10 to 10 V: E890 to 1770 Hex Full scale for other ranges: 0000 to 2EE0 Hex	
Averaging function		Supported (Set in output words n+1 and n+2.)			
Open-circuit detection function		Supported			
Conversion time		2 ms/point (8 ms/all points)		1 ms/point (4 ms/all points)	
Isolation method		Photocoupler isolation between analog I/O terminals and internal circuits. No isolation between analog I/O signals.			
Current consumption		5 VDC: 100 mA max.; 24 VDC: 90 mA max.		5 VDC: 100 mA max.; 24 VDC: 50 mA max.	

### ● Analog Output Units

Model		CP1W-DA021/CP1W-DA041		CP1W-DA042		
Item		Voltage Output	Current Output	Voltage Input	Current Input	
Analog output section	Number of outputs	CP1W-DA021: 2 outputs (2 words allocated) CP1W-DA041: 4 outputs (4 words allocated)		4 outputs (4 words allocated)		
	Output signal range	1 to 5 VDC, 0 to 10 VDC, or -10 to 10 VDC	0 to 20 mA or 4 to 20 mA	1 to 5 VDC, 0 to 10 VDC, or -10 to 10 VDC	0 to 20 mA or 4 to 20 mA	
	External output allowable load resistance	2 k $\Omega$ min.	350 $\Omega$ max.	2 k $\Omega$ min.	350 $\Omega$ max.	
	External output impedance	0.5 $\Omega$ max.	---	0.5 $\Omega$ max.	---	
	Resolution	1/6000 (full scale)		1/12000 (full scale)		
	Overall accuracy	25°C	0.4% full scale		0.3% full scale	
		0 to 55°C	0.8% full scale		0.7% full scale	
D/A conversion data	16-bit binary (4-digit hexadecimal) Full scale for -10 to 10 V: F448 to 0BB8 Hex Full scale for other ranges: 0000 to 1770 Hex		16-bit binary (4-digit hexadecimal) Full scale for -10 to 10 V: E890 to 1770 Hex Full scale for other ranges: 0000 to 2EE0 Hex			
Conversion time	CP1W-DA021: 2 ms/point (4 ms/all points) CP1W-DA041: 2 ms/point (8 ms/all points)		1 ms/point (4 ms/all points)			
Isolation method	Photocoupler isolation between analog I/O terminals and internal circuits. No isolation between analog I/O signals.					
Current consumption	CP1W-DA021: 5 VDC: 40 mA max.; 24 VDC: 95 mA max. CP1W-DA041: 5 VDC: 80 mA max.; 24 VDC: 124 mA max.		5 VDC: 70 mA max.; 24 VDC: 160 mA max.			

● Analog I/O Units

Model		CP1W-MAD42/CP1W-MAD44		CP1W-MAD11		
Item		Voltage I/O	Current I/O	Voltage I/O	Current I/O	
Analog Input Section	Number of inputs	4 inputs (4 words allocated)		2 inputs (2 words allocated)		
	Input signal range	0 to 5 VDC, 1 to 5 VDC, 0 to 10 VDC, or -10 to 10 VDC	0 to 20 mA or 4 to 20 mA	0 to 5 VDC, 1 to 5 VDC, 0 to 10 VDC, or -10 to 10 VDC	0 to 20 mA or 4 to 20 mA	
	Max. rated input	±15 V	±30 mA	±15 V	±30 mA	
	External input impedance	1 M Ω min.	Approx. 250 Ω	1 M Ω min.	Approx. 250 Ω	
	Resolution	1/12000 (full scale)		1/6000 (full scale)		
	Overall accuracy	25°C	0.2% full scale	0.3% full scale	0.3% full scale	0.4% full scale
		0 to 55°C	0.5% full scale	0.7% full scale	0.6% full scale	0.8% full scale
	A/D conversion data	16-bit binary (4-digit hexadecimal) Full scale for -10 to 10 V: E890 to 1770 hex Full scale for other ranges: 0000 to 2EE0 hex		16-bit binary (4-digit hexadecimal) Full scale for -10 to 10 V: F448 to 0BB8 hex Full scale for other ranges: 0000 to 1770 hex		
	Averaging function	Supported		Supported (Settable for individual inputs via DIP switch)		
Open-circuit detection function	Supported					
Analog Output Section	Number of outputs	CP1W-MAD42: 2 outputs (2 words allocated) CP1W-MAD44: 4 outputs (4 words allocated)		1 output (1 word allocated)		
	Output signal range	1 to 5 VDC, 0 to 10 VDC, or -10 to 10 VDC	0 to 20 mA or 4 to 20 mA	1 to 5 VDC, 0 to 10 VDC, or -10 to 10 VDC,	0 to 20 mA or 4 to 20 mA	
	Allowable external output load resistance	2 k Ω min.	350 Ω max.	1 k Ω min.	600 Ω max.	
	External output impedance	0.5 Ω max.	---	0.5 Ω max.	---	
	Resolution	1/12000 (full scale)		1/6000 (full scale)		
	Overall accuracy	25°C	0.3% full scale		0.4% full scale	
		0 to 55°C	0.7% full scale		0.8% full scale	
Set data (D/A conversion)	16-bit binary (4-digit hexadecimal) Full scale for -10 to 10 V: E890 to 1770 hex Full scale for other ranges: 0000 to 2EE0 hex		16-bit binary (4-digit hexadecimal) Full scale for -10 to 10 V: F448 to 0BB8 hex Full scale for other ranges: 0000 to 1770 hex			
Conversion time	CP1W-MAD42: 1 ms/point (6 ms/all points) CP1W-MAD44: 1 ms/point (8 ms/all points)		2 ms/point (6 ms/all points)			
Isolation method	Photocoupler isolation between analog I/O terminals and internal circuits. No isolation between analog I/O signals.					
Current consumption	CP1W-MAD42: 5 VDC: 120 mA max., 24 VDC: 120 mA max. CP1W-MAD44: 5 VDC: 120 mA max., 24 VDC: 170 mA max.		5 VDC: 83 mA max., 24 VDC: 110 mA max.			

● Temperature Sensors Units

Item	CP1W-TS001	CP1W-TS002	CP1W-TS101	CP1W-TS102
Temperature sensors	Thermocouples Switchable between K and J, but same type must be used for all inputs.		Platinum resistance thermometer Switchable between Pt100 and JPt100, but same type must be used for all inputs.	
Number of inputs	2	4	2	4
Allocated input words	2	4	2	4
Accuracy	(The larger of ±0.5% of converted value or ±2°C) ±1 digit max. *		(The larger of ±0.5% of converted value or ±1°C) ±1 digit max.	
Conversion time	250 ms for 2 or 4 input points			
Converted temperature data	16-bit binary data (4-digit hexadecimal)			
Isolation	Photocouplers between all temperature input signals			
Current consumption	5 VDC: 40 mA max., 24 VDC: 59 mA max.		5 VDC: 54 mA max., 24 VDC: 73 mA max.	

\* Accuracy for a K-type sensor at -100°C or less is ±4°C ±1 digit max.

The rotary switch is used to set the temperature range.

Setting	CP1W-TS001/TS002			CP1W-TS101/TS102			
	Input type	Range (°C)	Range (°F)	Input type	Range (°C)	Range (°F)	
	0	K	-200 to 1,300	-300 to 2,300	Pt100	-200.0 to 650.0	-300.0 to 1,200.0
	1		0.0 to 500.0	0.0 to 900.0	JPt100	-200.0 to 650.0	-300.0 to 1,200.0
	2	J	-100 to 850	-100 to 1,500	---	Cannot be set.	
	3		0.0 to 400.0	0.0 to 750.0	---		
	4 to F	---	Cannot be set.		---		

● Main Specifications

Item		CP1W-TS003
Temperature sensors		Thermocouples or analog input Switchable between K and J, but same type must be used for all inputs.
Number of inputs		Thermocouples inputs :4 , Analog inputs :2 Two analog inputs can be shared with thermocouples inputs.
Accuracy at 25°C	Thermocouple inputs	(The larger of ±0.5% of converted value or ±2°C) ±1 digit max. *1
	Analog voltage inputs	0.5% full scale
	Analog inputs	0.6% full scale
Accuracy at 0 to 55°C	Thermocouple inputs	(The larger of ±1% of converted value or ±4°C) ±1 digit max. *2
	Analog voltage inputs	1.0 % full scale
	Analog inputs	1.2 % full scale
Input signal range	Thermocouple inputs	K: -200.0 to 1300.0°C or .300.0 to 2300.0°F J: -100.0 to 850.0°C or .100.0 to 1500.0°F
	Analog voltage inputs	0 to 10V/1 to 5V
	Analog inputs	4 to 20mA
Resolution	Thermocouple inputs	0.1°C or 0.1°F
	Analog inputs	1/12000 (full scale)
Max. rated input	Analog voltage inputs	±15V
	Analog inputs	±30mA
External input impedance	Analog voltage inputs	1M Ω min.
	Analog inputs	Approx. 250 Ω
Open-circuit detection function		Supported
Averaging function		Unsupported
Conversion time		250 ms for 4 input points
Converted temperature data		16-bit binary data (4-digit hexadecimal)
Converted AD data		16-bit binary data (4-digit hexadecimal)
Isolation		Photocouplers between any two input signals
Current consumption		5 VDC: 70 mA max., 24 VDC: 30 mA max.

\* 1 Accuracy for a K-type sensor at -100°C or less is ±4°C ±1 digit max.

\* 2 Accuracy for a K-type sensor at -100°C or less is ±10°C ±1 digit max.

DIP Switch Settings

The DIP switch is used to set the input type (temperature or analog input), the input thermocouple type (K or J) and the temperature unit (°C or °F).

**Note:** Set the temperature range according to the type of temperature sensor connected to the Unit. Temperature data will not be converted correctly if the temperature range does not match the sensor.

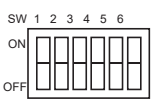
SW		Setting		
	1	Thermocouple type of temperature sensor	ON	J
			OFF	K
	2	Temperature unit	ON	°F
			OFF	°C
	3	NC		
	4	Input type selection for the third input (Input 2)	ON	Analog input
OFF			Thermocouple	
5	Input type selection for the fourth input (Input 3)	ON	Analog input	
		OFF	Thermocouple	
6	Analog input signal range	ON	1 to 5V/4 to 20mA	
		OFF	0 to 10V	

Temperature input		
Input type	Range (°C)	Range (°F)
K	-200.0 to 1300.0	-300 to 2300
J	-100.0 to 850.0	-100.0 to 1500

● Main Specifications

Item		CP1W-TS004
Temperature sensors		Thermocouples Switchable between K and J, but same type must be used for all inputs.
Number of inputs		12 (2 input words and 1 output word allocated)
Accuracy	25°C	(The larger of ±0.5% of converted value or ±2°C) ±1 digit max. *1
	0 to 55°C	(The larger of ±1% of converted value or ±4°C) ±1 digit max. *2
Conversion time		500 ms for 12 input points
Converted temperature data		16-bit binary data (4-digit hexadecimal) 2-decimal-place mode is not supported
Isolation		Photocouplers between any two input signals
Current consumption		5 VDC: 80 mA max., 24 VDC: 50 mA max.

\* 1 Accuracy for a K-type sensor at -100°C or less is ±4°C ±1 digit max.

\* 2 Accuracy for a K-type sensor at -100°C or less is ±10°C ±1 digit max.

DIP Switch Settings

The DIP switch is used to set the temperature unit and to set the temperature input range.

**Note:** Set the temperature range according to the type of temperature sensor connected to the Unit. Temperature data will not be converted correctly if the temperature range does not match the sensor.

SW		Setting	
	1	Input type	ON J OFF K
	2	Temperature unit	ON °F OFF °C

Temperature input		
Input type	Range (°C)	Range (°F)
K	-200.0 to 1300.0	-300 to 2300
J	-100.0 to 850.0	-100.0 to 1500

● CompoBus/S I/O Link Unit

Model number		CP1W-SRT21
Master/slave		CompoBus/S Slave
Number of I/O points		8 input points, 8 output points
Number of words allocated in CPU Unit I/O memory		1 input word, 1 output word
Node number setting		Set using the DIP switch (Set before turning on the CPU Unit's power supply.)

## Analog Option Board

An analog option board can be added to the CP1E-N/NA@@.

**Note:** 1. Can be used for the CP1E-N/NA@@ version 1.2 or later.

2. Analog boards can not be used for E@@-type and N@@S(1)-type.

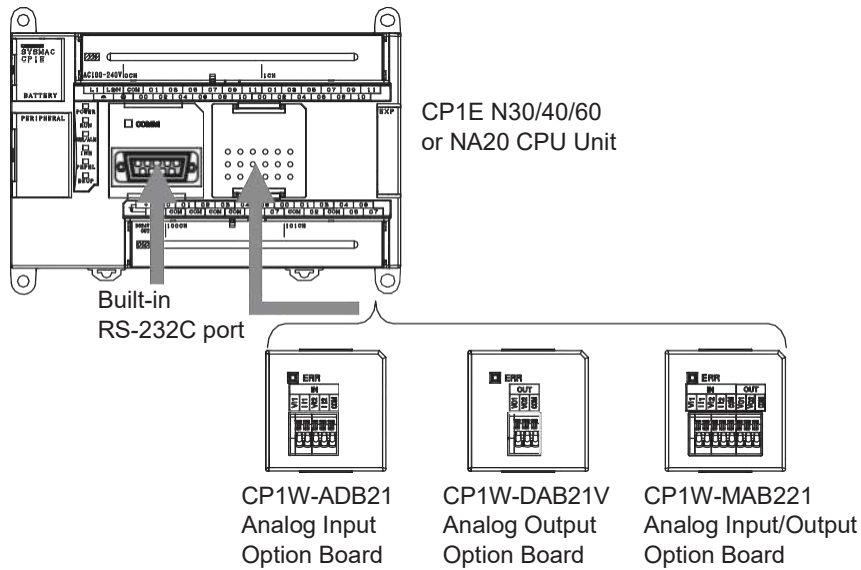

## Specifications of Analog Option Board

### ● CP1W-ADB21

Item	Specifications	
	Voltage Input	Current Input
Input signal range	0 to 10 VDC	0 to 20 mA
Max. rated input	0 to 15 VDC	0 to 30 mA
External input impedance	200 k $\Omega$ min.	Approx. 250 $\Omega$
Resolution	1/4000 (full scale)	1/2000 (full scale)
Overall accuracy	25°C	0.5% full scale
	0 to 55°C	1.0% full scale
A/D conversion data	0000 to 0FA0 Hex	0000 to 07D0 Hex
Averaging function	None	
Isolation method	No isolation between analog I/O terminals and internal circuits.	
Current consumption	5 VDC: 20 mA max.	

### ● CP1W-DAB21V

Item	Specifications	
	Voltage Output	Current Output
Output signal range	0 to 10 VDC	---
External output allowable load resistance	2 k $\Omega$ min.	---
External output impedance	0.5 $\Omega$ max.	---
Resolution	1/4000 (full scale)	---
Overall accuracy	25°C	0.5% full scale
	0 to 55°C	1.0% full scale
Set data (D/A conversion)	0000 to 0FA0 Hex	---
Isolation method	No isolation between analog I/O terminals and internal circuits.	
Current consumption	5 VDC: 60 mA max.	

### ● CP1W-MAB221

Item	Specifications		
	Voltage I/O	Current I/O	
Analog Input Section	Input signal range	0 to 10 VDC	
	Max. rated input	0 to 15 VDC	
	External input impedance	200 k $\Omega$ min.	
	Resolution	1/4000 (full scale)	
	Overall accuracy	25°C	0.5% full scale
		0 to 55°C	1.0% full scale
	A/D conversion data	0000 to 0FA0 Hex	
Averaging function	None		
Analog Output Section	Output signal range	0 to 10 VDC	
	External output allowable load resistance	2 k $\Omega$ min.	
	External output impedance	0.5 $\Omega$ max.	
	Resolution	1/4000 (full scale)	
	Overall accuracy	25°C	0.5% full scale
		0 to 55°C	1.0% full scale
	Set data (D/A conversion)	0000 to 0FA0 Hex	
Isolation method	No isolation between analog I/O terminals and internal circuits.		
Current consumption	5 VDC: 80 mA max.		

**Analog Option Board Refresh Time**

Analog Option Board	Cycle time		
	1 ms	10 ms	20 ms
CP1W-ADB21	40 ms $\pm$ 30%	50 ms $\pm$ 30%	80 ms $\pm$ 30%
CP1W-DAB21V	30 ms $\pm$ 40%	40 ms $\pm$ 50%	70 ms $\pm$ 40%
CP1W-MAB221(AD)	60 ms $\pm$ 40%	80 ms $\pm$ 60%	100 ms $\pm$ 50%
CP1W-MAB221(DA)	40 ms $\pm$ 80%	60 ms $\pm$ 60%	90 ms $\pm$ 50%



## External Interfaces

The CP1E CPU Units provide the following external interfaces.

### E14/20S CPU Units

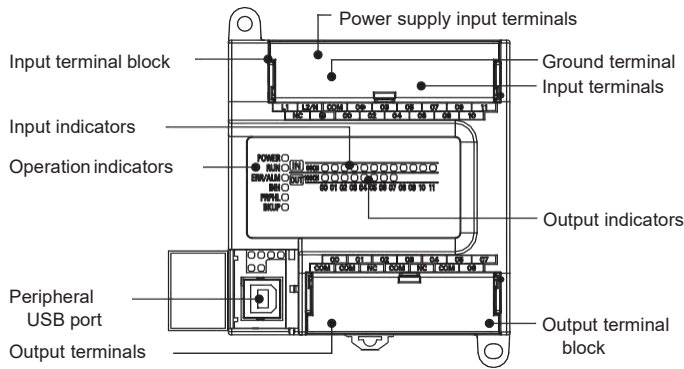

### E30/40/60S CPU Units

E@@S-type

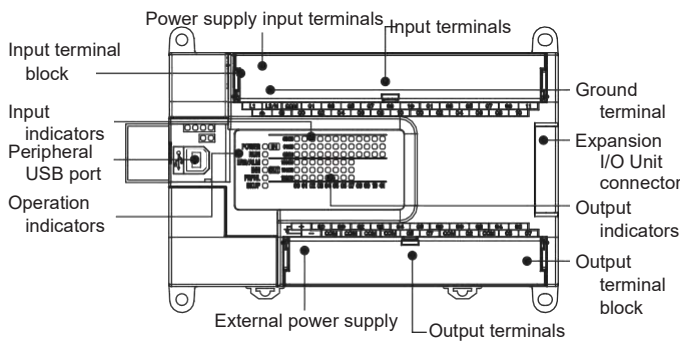

### N30/40/60S(1) CPU Units

N@@S(1)-type

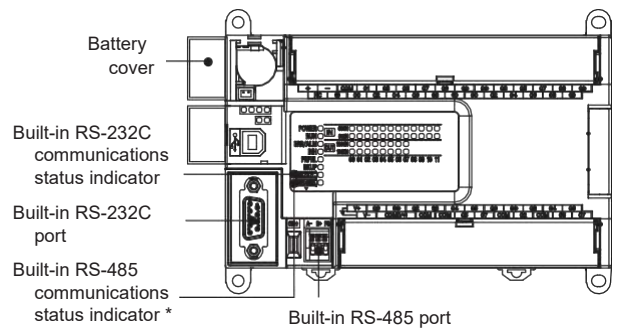

\* N@@S1-type only.

### E10/14/20 CPU Units

E@@-type

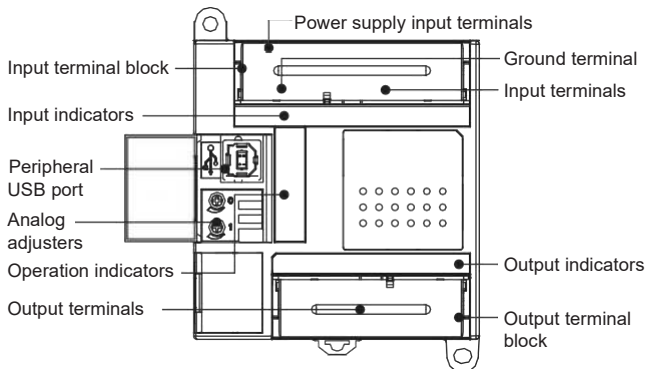

### N14/20 CPU Units

N@@-type

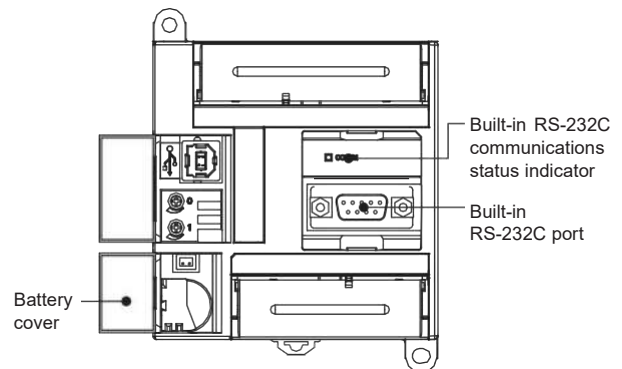

**Note:** Terminal Block (Fixed)

### E30/40 CPU Units

E@@-type

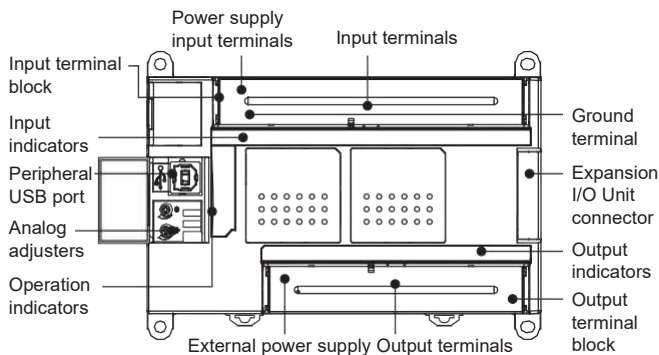

**Note:** Terminal Block (Fixed)

### N30/40/60 or NA20 CPU Units

N@@-type/NA-type

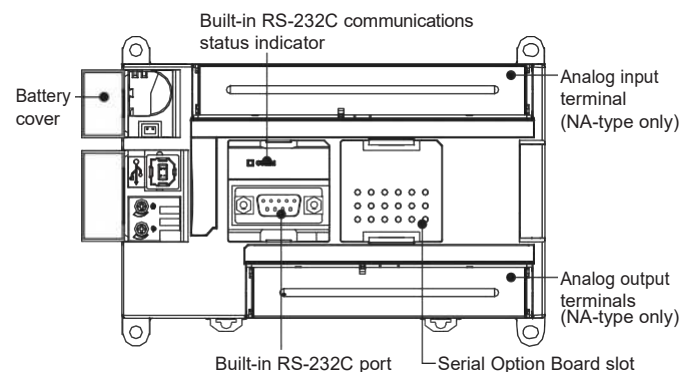

# CP1E-E@@(S)D@-@ CP1E-N@@(S@)D@-@/NA20D@-@

## Serial Communications Port for N/NA@@(S@)-type CPU Units

The Serial Communication Port can be used for a CP1E N/NA@@(S@)-type CPU Unit.

### N30/40/60S1 CPU Units

Built-in RS-232C, RS-485 ports.

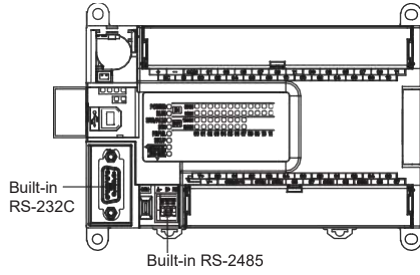

### N30/40/60S CPU Units

Built-in RS-232C port.

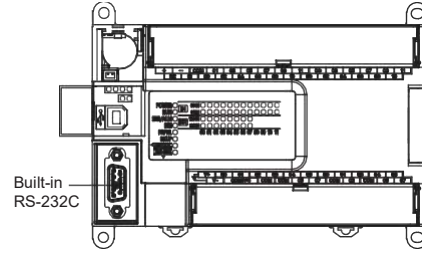

### N30/40/60 or NA20 CPU Units

One built-in RS-232C port and one Option Board can be used.

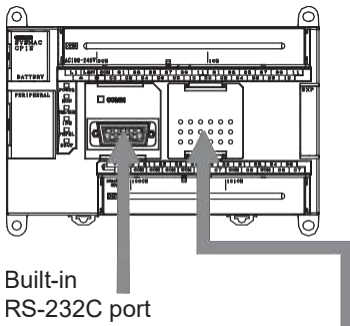

#### Optional Serial Communication Board

Model number	Port	Maximum transmission distance	Connection method
CP1W-CIF01	One RS-232C port	15 m	Connector (D-sub, 9 pin female)
CP1W-CIF11	One RS-422A/485 port (not isolated)	50 m	Terminal block (using ferrules)
CP1W-CIF12-V1	One RS-422A/485 port (isolated)	500 m	Terminal block (using ferrules)
CP1W-CIF41	One Ethernet port	100 m	Connector (RJ45, 8 pin modular)

**Note:** The Optional Serial Communication Board cannot be used for CP1E N/NA@@S(1)-type CPU Units and E@@-type CPU Units.

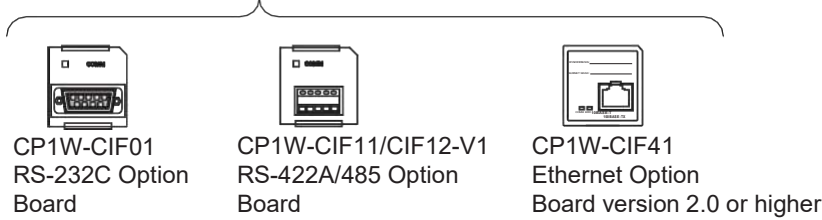

### N14/20 CPU Units

Built-in RS-232C ports.

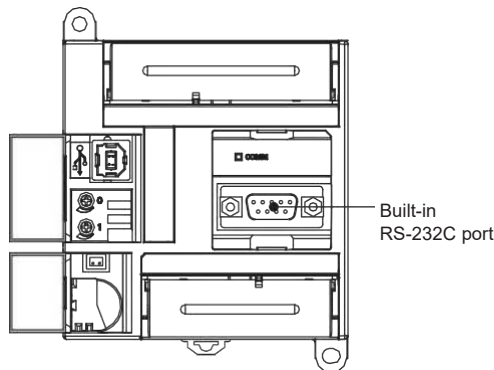

Note: Option Boards cannot be used for CP1E N14/20 CPU Units.

## Built-in RS-232C Port and CP1W-CIF01 RS-232C Option Board

### ● RS-232C Connector

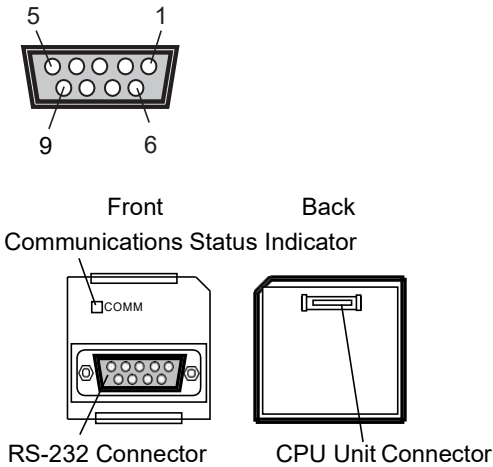

Pin	Abbreviation for signal name		Signal name	Signal direction
	N@@-type built-in RS-232C port / CP1W-CIF01	N@@S(1)-type Built-in RS-232C port		
1	FG		Frame ground	--
2	SD (TXD)		Send data	Output
3	RD (RXD)		Receive data	Input
4	RS (RTS)		Request to send	Output
5	CS (CTS)		Clear to send	Input
6	5 V		Power supply	--
7	DR (DSR)	NC *	Data set ready	Input
8	ER (DTR)	NC *	Data terminal ready	Output
9	SG (0 V)		Signal ground	--
Connector hood	FG		Frame Ground	--

\* Built-in RS-232C port of N@@S(1)-type does not support DR/ER.  
CJ1W-CIF11 cannot be used for the built-in RS-232C port of N@@S(1)-type.

## Built-in RS-232C Port (2-wire sensors) (N@@S1-type only)

### ● RS-485 Terminal Block

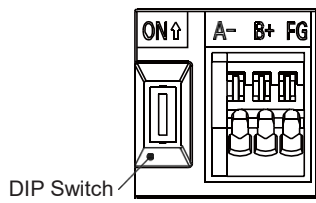

### ● DIP Switch for Terminating Resistance Settings

Settings		
ON	ON (both ends)	Terminating resistance selection
OFF	OFF	Resistance: Approx. 220 Ω

## CP1W-CIF11/CIF12-V1 RS-422A/485 Option Board

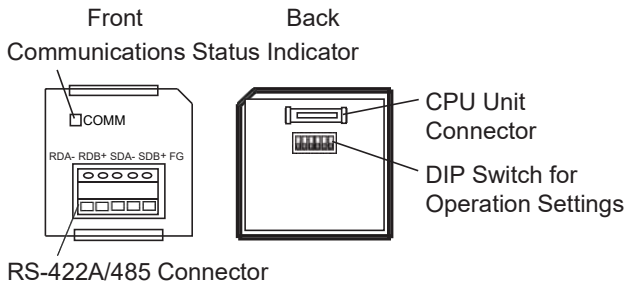

### ● RS-422A/485 Terminal Block

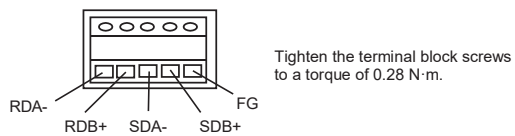

**CP1W-CIF41 Ethernet Option Board version 2.0 or higher**

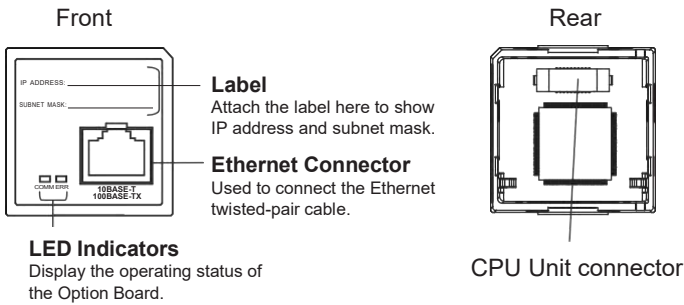

● **Specifications**

<b>Type</b>	100/10Base-TX (Auto-MDIX)		
<b>Support Software</b>	CX-Programmer version 9.12 or higher		
<b>Transfer</b>	<b>Media access method</b>	CSMA/CD	
	<b>Modulation method</b>	Baseband	
	<b>Transmission paths</b>	Star form	
	<b>Baud rate</b>	100 Mbit/s (100Base-TX)	10 Mbit/s (10Base-TX)
		<ul style="list-style-type: none"> <li>• Half/full auto-negotiation for each port</li> <li>• Link speed auto-sensing for each port</li> </ul>	
	<b>Transmission media</b>	<ul style="list-style-type: none"> <li>• Unshielded twisted-pair (UDP) cable Categories: 5, 5e</li> <li>• Shielded twisted-pair (STP) cable Categories: 100 Ω at 5, 5e</li> </ul>	<ul style="list-style-type: none"> <li>• Unshielded twisted-pair (UDP) cable Categories: 3, 4, 5, 5e</li> <li>• Shielded twisted-pair (STP) cable Categories: 100 Ω at 3, 4, 5, 5e</li> </ul>
<b>Transmission Distance</b>		100 m (distance between hub and node)	
<b>Number of cascade connections</b>	No restrictions if switching hubs are used.		

● **FINS Communications Service Specifications**

<b>Number of nodes</b>	254	
<b>Message Length</b>	552 bytes max.	
<b>Date Length</b>	540 bytes max. (except for FINS header 10 byte and Command header 2 byte.)	
<b>Number of buffer</b>	8k byte	
<b>Protocol name</b>	FINS/UDP method	FINS/TCP method
<b>Protocol used</b>	UDP/IP	TCP/IP
	The selection of UDP/IP or TCP/IP is made from the FINS/TCP Tab by the Web browser function.	
<b>Server/Client</b>	Only server (Cannot be used as a client)	
<b>Number of connections</b>	---	2
<b>Port number</b>	9600 (default) Can be changed.	9600 (default) Can be changed.
	<b>Protection</b>	
No		Yes (Specification of client IP addresses when unit is used as a server)

**Connecting to Support Software**

**Connecting Methods**

Using commercially available USB cable, connect the CX-Programmer to the peripheral USB port on the CPU Unit. Host link connection can be made with RS-232C port to connect the Programming Device (CX-Programmer).

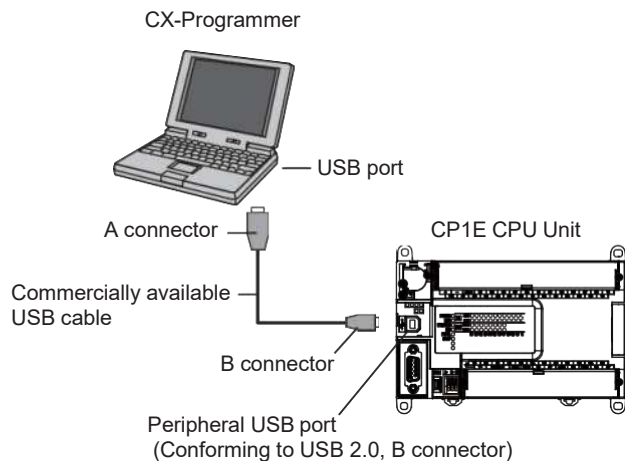

## Connecting Cable

Use the following cable to connect the CP1E CPU Unit to the computer running the Support Software.

### USB port

Port at Unit	Port at computer	Network type (communications mode)	Model numbers	Length
Peripheral USB port (Conforming to USB 2.0, B connector)	USB port	USB 2.0 (or 1.1)	Commercially available USB cable (A connector - B connector)	Less than 5 m

### RS-232C Port for N/NA@@(S@)-type CPU Units

Port at Unit	Port at computer	Communications mode	Connecting Cable		
			Model	Length	Remarks
RS-232C Port or CP1W-CIF01 (Add this to the option board slot.)	RS-232C port *	Host Link (SYSWAY)	XW2Z-200S-CV	2m	With anti-static connectors
			XW2Z-500S-CV	5m	With anti-static connectors
			XW2Z-200S-V	2m	---
			XW2Z-500S-V	5m	---

**Note:** Connectable with CX-Programmer Ver.9.1 or higher only.

\* Use the USB-Serial Conversion Cable CS1W-CIF31 together to connect a PLC to a personal computer's USB port.

## Programming Instructions

### Sequence Input Instructions

Instruction	Mnemonic
LOAD	LD
LOAD NOT	LD NOT
AND	AND
AND NOT	AND NOT
OR	OR
OR NOT	OR NOT
AND LOAD	AND LD
OR LOAD	OR LD
NOT	NOT
CONDITION ON	UP
CONDITION OFF	DOWN

### Sequence Output Instructions

Instruction	Mnemonic
OUTPUT	OUT
OUTPUT NOT	OUT NOT
KEEP	KEEP
DIFFERENTIATE UP	DIFU
DIFFERENTIATE DOWN	DIFD
SET	SET
RESET	RSET
MULTIPLE BIT SET	SETA
MULTIPLE BIT RESET	RSTA
SINGLE BIT SET	SETB
SINGLE BIT RESET	RSTB

### Sequence Output Instructions

Instruction	Mnemonic
END	END
NO OPERATION	NOP
INTERLOCK	IL
INTERLOCK CLEAR	ILC
MULTI-INTERLOCK DIFFERENTIATION HOLD	MILH
MULTI-INTERLOCK DIFFERENTIATION RELEASE	MILR
MULTI-INTERLOCK CLEAR	MILC
JUMP	JMP
JUMP END	JME
CONDITIONAL JUMP	CJP
FOR LOOP	FOR
BREAK LOOP	BREAK
NEXT LOOP	NEXT

### Timer and Counter Instructions

Instruction	Mnemonic
TIMER	TIM
	TIMX
COUNTER	CNT
	CNTX
HIGH-SPEED TIMER	TIMH
	TIMHX
ONE-MS TIMER	TMHH
	TMHHX
ACCUMULATIVE TIMER	TTIM
	TTIMX
LONG TIMER	TIML
	TIMLX
REVERSIBLE COUNTER	CNTR
	CNTRX
RESET TIMER/COUNTER	CNR
	CNRX

### Comparison Instructions

Instruction	Mnemonic
Input Comparison Instructions (unsigned)	LD,AND,OR+=
	LD,AND,OR+<>
	LD,AND,OR+<
	LD,AND,OR+<=
	LD,AND,OR+>
Input Comparison Instructions (double, unsigned)	LD,AND,OR+>=
	LD,AND,OR+=+L
	LD,AND,OR+<>+L
	LD,AND,OR+<+L
	LD,AND,OR+<=+L
Input Comparison Instructions (double, signed)	LD,AND,OR+>+L
	LD,AND,OR+>=+L
	LD,AND,OR+=+S
	LD,AND,OR+<>+S
	LD,AND,OR+<+S
Input Comparison Instructions (signed)	LD,AND,OR+<=+S
	LD,AND,OR+>+S
	LD,AND,OR+>=+S
	LD,AND,OR+=+SL
	LD,AND,OR+<>+SL
Input Comparison Instructions (double, signed)	LD,AND,OR+<+SL
	LD,AND,OR+<=+SL
	LD,AND,OR+>+SL
	LD,AND,OR+>=+SL
	Time Comparison Instructions
<>DT	
<DT	
<=DT	
>DT	
COMPARE	>=DT
	CMP
	CMPL
	CPS
	CPSL
TCMP	
BCMP	
ZCP	
ZCPL	

### Data Movement Instructions

Instruction	Mnemonic
MOVE	MOV
DOUBLE MOVE	MOVL
MOVE NOT	MVN
MOVE BIT	MOVB
MOVE DIGIT	MOVD
MULTIPLE BIT TRANSFER	XFRB
BLOCK TRANSFER	XFER
BLOCK SET	BSET
DATA EXCHANGE	XCHG
SINGLE WORD DISTRIBUTE	DIST
DATA COLLECT	COLL

### Data Shift Instructions

Instruction	Mnemonic
SHIFT REGISTER	SFT
REVERSIBLE SHIFT REGISTER	SFTR
WORD SHIFT	WSFT
ARITHMETIC SHIFT LEFT	ASL
ARITHMETIC SHIFT RIGHT	ASR
ROTATE LEFT	ROL
ROTATE RIGHT	ROR
ONE DIGIT SHIFT LEFT	SLD
ONE DIGIT SHIFT RIGHT	SRD
SHIFT N-BITS LEFT	NASL
DOUBLE SHIFT N-BITS LEFT	NSLL
SHIFT N-BITS RIGHT	NASR
DOUBLE SHIFT N-BITS RIGHT	NSRL

### Increment/Decrement Instructions

Instruction	Mnemonic
INCREMENT BINARY	++
DOUBLE INCREMENT BINARY	++L
DECREMENT BINARY	--
DOUBLE DECREMENT BINARY	--L
INCREMENT BCD	++B
DOUBLE INCREMENT BCD	++BL
DECREMENT BCD	--B
DOUBLE DECREMENT BCD	--BL

### Symbol Math Instructions

Instruction	Mnemonic
SIGNED BINARY ADD WITHOUT CARRY	+
DOUBLE SIGNED BINARY ADD WITHOUT CARRY	+L
SIGNED BINARY ADD WITH CARRY	+C
DOUBLE SIGNED BINARY ADD WITH CARRY	+CL
BCD ADD WITHOUT CARRY	+B
DOUBLE BCD ADD WITHOUT CARRY	+BL
BCD ADD WITH CARRY	+BC
DOUBLE BCD ADD WITH CARRY	+BCL
SIGNED BINARY SUBTRACT WITHOUT CARRY	-
DOUBLE SIGNED BINARY SUBTRACT WITHOUT CARRY	-L
SIGNED BINARY SUBTRACT WITH CARRY	-C
DOUBLE SIGNED BINARY SUBTRACT WITH CARRY	-CL
BCD SUBTRACT WITHOUT CARRY	-B
DOUBLE BCD SUBTRACT WITHOUT CARRY	-BL
BCD SUBTRACT WITH CARRY	-BC
DOUBLE BCD SUBTRACT WITH CARRY	-BCL
SIGNED BINARY MULTIPLY	*
DOUBLE SIGNED BINARY MULTIPLY	*L
BCD MULTIPLY	*B
DOUBLE BCD MULTIPLY	*BL
SIGNED BINARY DIVIDE	/
DOUBLE SIGNED BINARY DIVIDE	/L
BCD DIVIDE	/B
DOUBLE BCD DIVIDE	/BL

### Conversion Instructions

Instruction	Mnemonic
BCD-TO-BINARY	BIN
DOUBLE BCD-TO-DOUBLE BINARY	BINL
BINARY-TO-BCD	BCD
DOUBLE BINARY-TO-DOUBLE BCD	BCDL
2'S COMPLEMENT	NEG
DATA DECODER	MLPX
DATA ENCODER	DMPX
ASCII CONVERT	ASC
ASCII TO HEX	HEX

### Logic Instructions

Instruction	Mnemonic
LOGICAL AND	ANDW
DOUBLE LOGICAL AND	ANDL
LOGICAL OR	ORW
DOUBLE LOGICAL OR	ORWL
EXCLUSIVE OR	XORW
DOUBLE EXCLUSIVE OR	XORL
COMPLEMENT	COM
DOUBLE COMPLEMENT	COML

### Special Math Instructions

Instruction	Mnemonic
ARITHMETIC PROCESS	APR
BIT COUNTER	BCNT

### Floating-point Math Instructions

Instruction	Mnemonic
FLOATING TO 16-BIT	FIX
FLOATING TO 32-BIT	FIXL
16-BIT TO FLOATING	FLT
32-BIT TO FLOATING	FLT L
FLOATING-POINT ADD	+F
FLOATING-POINT SUBTRACT	-F
FLOATING-POINT DIVIDE	/F
FLOATING-POINT MULTIPLY	*F
Floating Symbol Comparison	LD, AND, OR+=F
	LD, AND, OR+<>F
	LD, AND, OR+<F
	LD, AND, OR+<=F
	LD, AND, OR+>F
LD, AND, OR+>=F	
FLOATING- POINT TO ASCII	FSTR
ASCII TO FLOATING-POINT	FVAL

### Table Data Processing Instructions

Instruction	Mnemonic
SWAP BYTES	SWAP
FRAME CHECKSUM	FCS

### Data Control Instructions

Instruction	Mnemonic
PID CONTROL WITH AUTOTUNING	PIDAT
TIME-PROPORTIONAL OUTPUT	TPO
SCALING	SCL
SCALING 2	SCL2
SCALING 3	SCL3
AVERAGE	AVG

## Subroutine Instructions

Instruction	Mnemonic
SUBROUTINE CALL	SBS
SUBROUTINE ENTRY	SBN
SUBROUTINE RETURN	RET

## Interrupt Control Instructions

Instruction	Mnemonic
SET INTERRUPT MASK	MSKS
CLEAR INTERRUPT	CLI
DISABLE INTERRUPTS	DI
ENABLE INTERRUPTS	EI

## High-speed Counter and Pulse Output Instructions

Instruction	Mnemonic
MODE CONTROL	INI
HIGH-SPEED COUNTER PV READ	PRV
COMPARISON TABLE LOAD	CTBL
SPEED OUTPUT	SPED
SET PULSES	PULS
PULSE OUTPUT	PLS2
ACCELERATION CONTROL	ACC
ORIGIN SEARCH	ORG
PULSE WITH VARIABLE DUTY FACTOR	PWM

## Step Instructions

Instruction	Mnemonic
STEP DEFINE	STEP
STEP START	SNXT

## I/O Unit Instructions

Instruction	Mnemonic
I/O REFRESH	IORF
7-SEGMENT DECODER	SDEC
DIGITAL SWITCH INPUT	DSW
MATRIX INPUT	MTR
7-SEGMENT DISPLAY OUTPUT	7SEG

## Serial Communications Instructions

Instruction	Mnemonic
TRANSMIT	TXD
RECEIVE	RXD

## Clock Instructions

Instruction	Mnemonic
CALENDAR ADD	CADD
CALENDAR SUBTRACT	CSUB
CLOCK ADJUSTMENT	DATE

## Failure Diagnosis Instructions

Instruction	Mnemonic
FAILURE ALARM	FAL
SEVERE FAILURE ALARM	FALS

## Other Instructions

Instruction	Mnemonic
SET CARRY	STC
CLEAR CARRY	CLC
EXTEND MAXIMUM CYCLE TIME	WDT



## Dimensions

### CP1E CPU Unit

#### ● CPU Units with 10 I/O Points

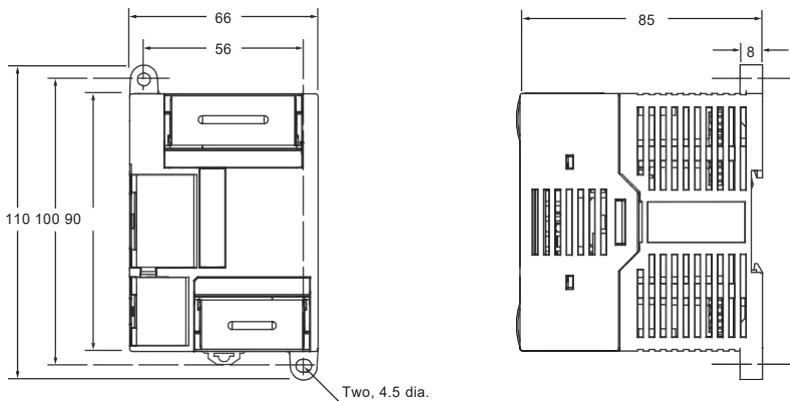

#### ● CPU Units with 14 or 20 I/O Points

#### CP1E-@14/20D@-@-@

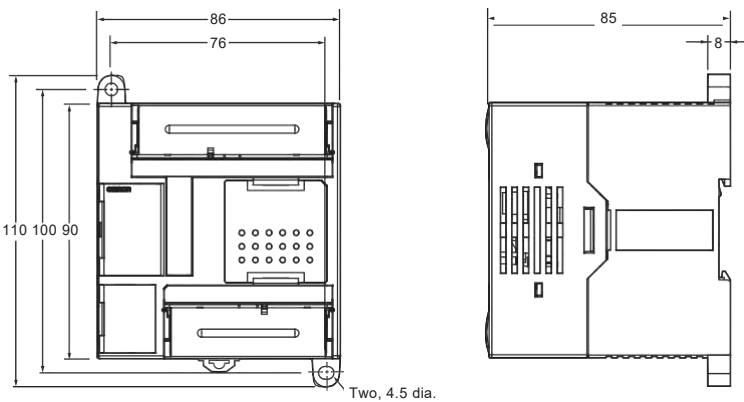

#### CP1E-@14/20SD@-@-@

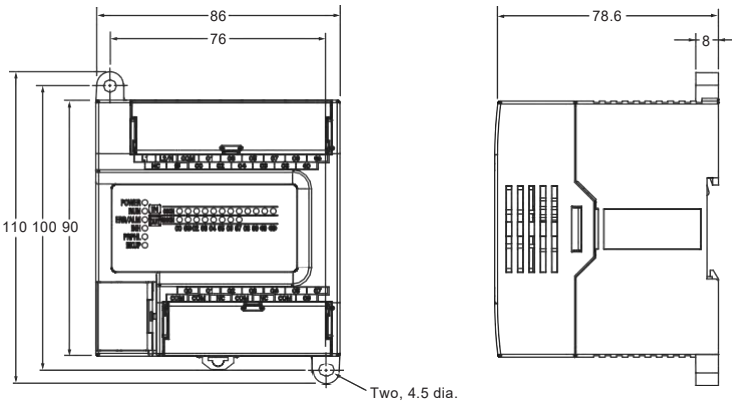

#### ● CPU Units with 30 I/O Points

#### ● CPU Units with 20 I/O Points and Built-in Analog

#### CP1E-@30D@-@-@, CP1E-NA20D@-@

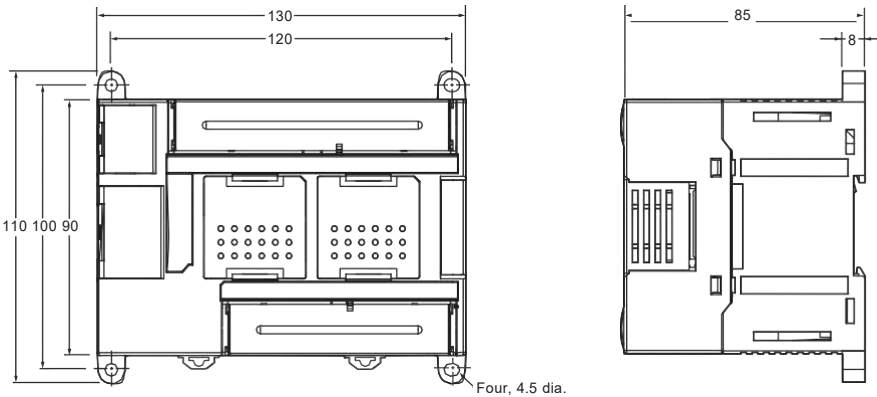

# CP1E-E@@(S)D@-@ CP1E-N@@(S@)D@-@/NA20D@-@

## CP1E-@30S(1)D@@-@

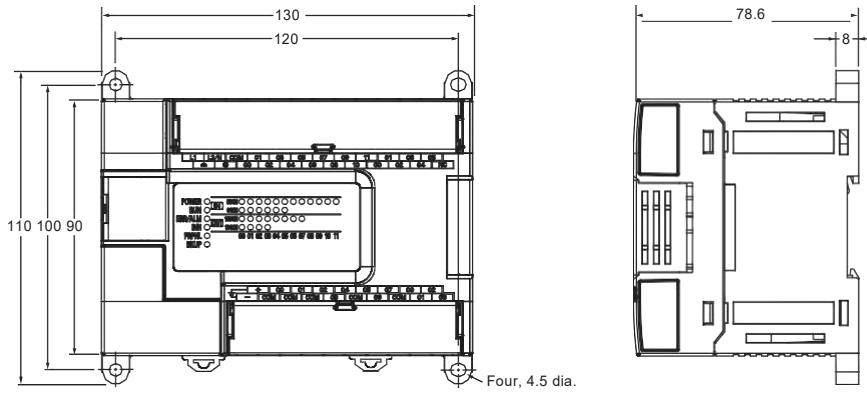

### ● CPU Units with 40 I/O Points

#### CP1E-@40D@@-@

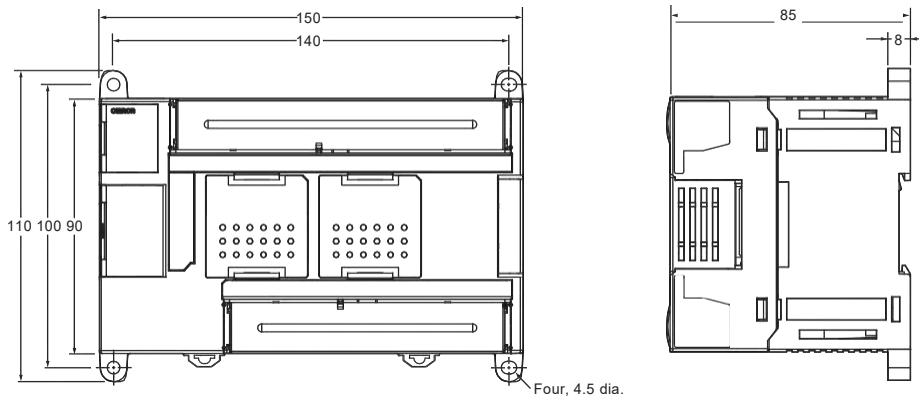

#### CP1E-@40S(1)D@@-@

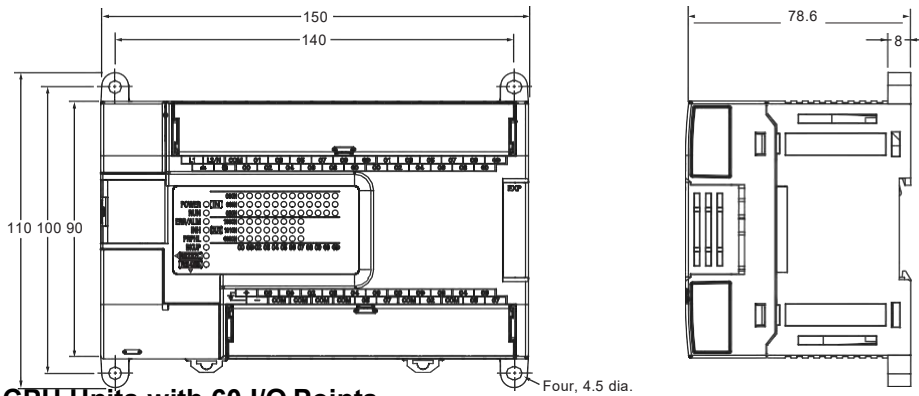

### ● CPU Units with 60 I/O Points

#### CP1E-N60D@-@

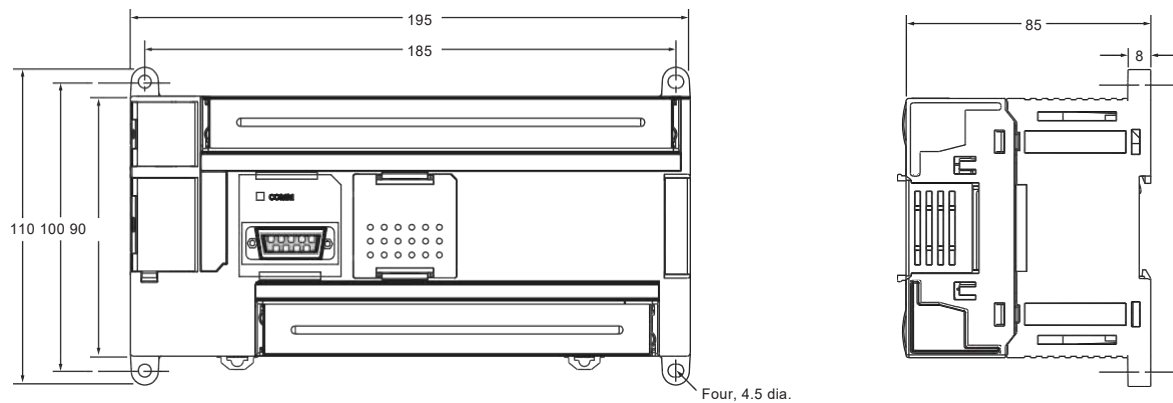

CP1E-@60S(1)D@-@

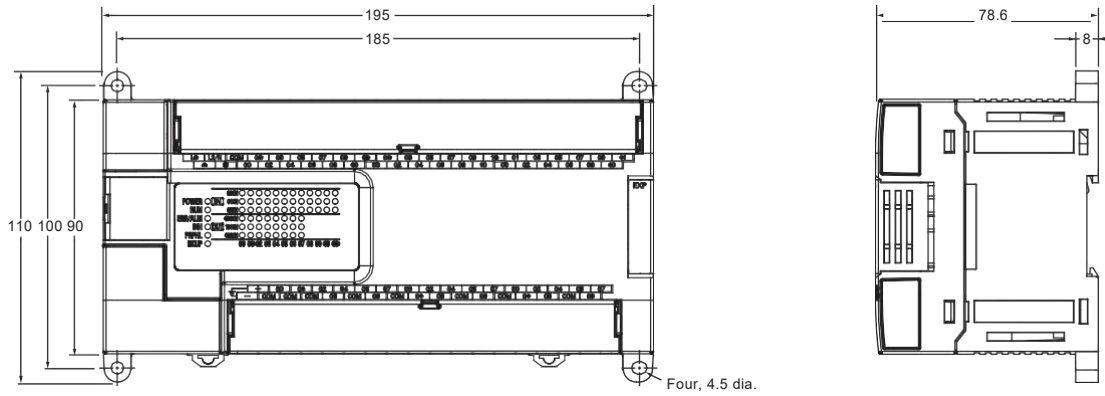

Expansion I/O Units and Expansion Units

● CP1W-8E@@/CP1W-SRT21

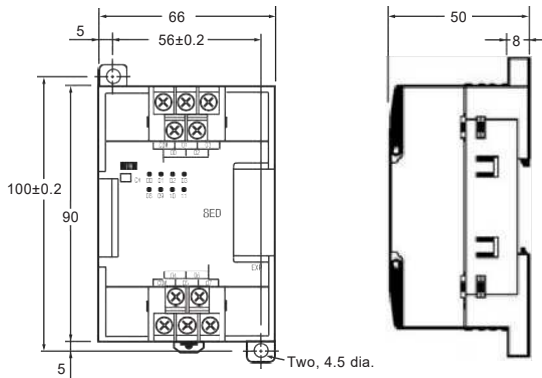

● CP1W-20ED@/CP1W-16E@@/CP1W-AD04@/CP1W-DA021/CP1W-DA04@/CP1W-MAD@@/  
CP1W-TS@@1@@2@@3

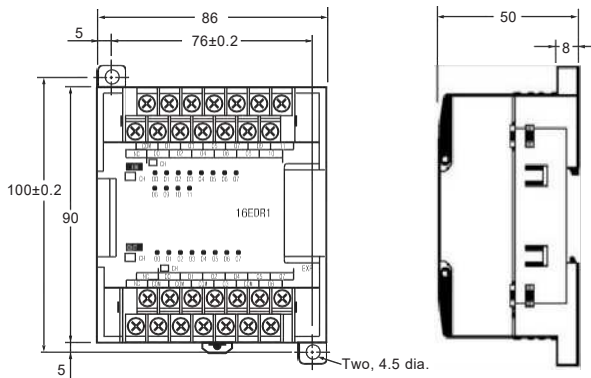

● CP1W-40ED@/CP1W-32E@@/CP1W-TS004

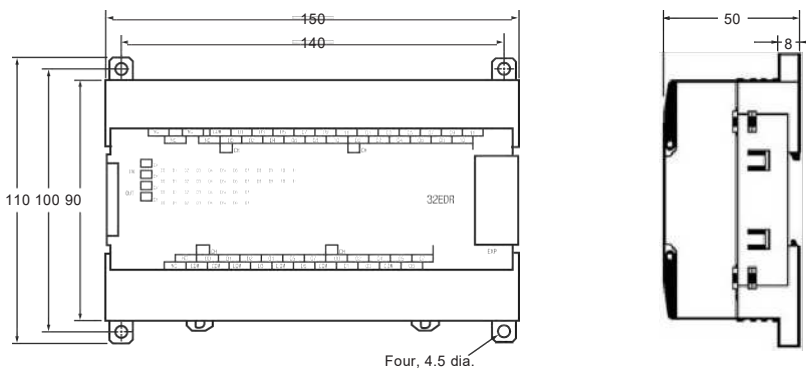

# CP1E-E@@(S)D@-@ CP1E-N@@(S@)D@-@NA20D@-@

## Related Manuals

Manual name	Cat. No.	Model numbers	Application	Contents
SYSMAC CP Series CP1E CPU Unit Hardware Manual	W479	CP1E-E@@SD@-@ CP1E-N@@S@D@-@ CP1E-E@@D@-@ CP1E-N@@D@-@ CP1E-NA@@D@-@	To learn the hardware specifications of the CP1E PLCs	Describes the following information for CP1E PLCs. <ul style="list-style-type: none"> <li>• Overview and features</li> <li>• Basic system configuration</li> <li>• Part names and functions</li> <li>• Installation and settings</li> <li>• Troubleshooting</li> </ul>
			Use this manual together with the CP1E CPU Unit Software Manual (Cat. No. W480) and CP1E CPU Unit Instructions Reference Manual (Cat. No. W483).	
SYSMAC CP Series CP1E CPU Unit Software Manual	W480	CP1E-E@@SD@-@ CP1E-N@@S@D@-@ CP1E-E@@D@-@ CP1E-N@@D@-@ CP1E-NA@@D@-@	To learn the software specifications of the CP1E	Describes the following information for CP1E PLCs. <ul style="list-style-type: none"> <li>• CPU Unit operation</li> <li>• Internal memory</li> <li>• Programming</li> <li>• Settings</li> <li>• CPU Unit built-in functions</li> <li>• Interrupts</li> <li>• High-speed counter inputs</li> <li>• Pulse outputs</li> <li>• Serial communications</li> <li>• Analog I/O function</li> <li>• Other functions</li> </ul>
			Use this manual together with the CP1E CPU Unit Hardware Manual (Cat. No. W479) and CP1E CPU Unit Instructions Reference Manual (Cat. No. W483).	
SYSMAC CP Series CP1E CPU Unit Instructions Reference Manual	W483	CP1E-E@@SD@-@ CP1E-N@@S@D@-@ CP1E-E@@D@-@ CP1E-N@@D@-@ CP1E-NA@@D@-@	To learn programming instructions in detail	Describes each programming instruction in detail. When programming, use this manual together with the CP1E CPU Unit Hardware Manual (Cat. No. W479) and CP1E CPU Unit Software Manual (Cat. No. W480).
CS/CJ/CP/NSJ Series Communications Commands Reference Manual	W342	CS1G/H-CPU@@H CS1G/H-CPU@@-V1 CS1D-CPU@@HA CS1D-CPU@@SA CS1D-CPU@@H CS1D-CPU@@S CS1W-SCU@@-V1 CS1W-SCB@@-V1 CJ1G/H-CPU@@H CJ1G-CPU@@P CJ1M-CPU@@ CJ1G-CPU@@ CJ1W-SCU@@-V1	To learn communications commands for CS/CJ/CP/NSJ-series Controllers in detail  <b>Note:</b> This manual describes commands addressed to CPU Units. It does not cover commands addressed to other Units or ports (e.g., serial communications ports on CPU Units, communications ports on Serial Communications Units/Boards, and other Communications Units).	Describes 1) C-mode commands and 2) FINS commands in detail. Read this manual for details on C-mode and FINS commands addressed to CPU Units.
SYSMAC CP Series CP1L/CP1E CPU Unit Introduction Manual	W461	CP1L-L10D@-@ CP1L-L14D@-@ CP1L-L20D@-@ CP1L-M30D@-@ CP1L-M40D@-@ CP1L-M60D@-@ CP1E-E@@D@-@ CP1E-N@@D@-@ CP1E-NA@@D@-@	To learn the basic setup methods of the CP1L/CP1E PLCs	Describes the following information for CP1L/CP1E PLCs. <ul style="list-style-type: none"> <li>• Basic configuration and component names</li> <li>• Mounting and wiring</li> <li>• Programming, data transfer, and debugging using the CX-Programmer</li> <li>• Application program examples</li> </ul>

# Terms and Conditions Agreement

## **Read and understand this catalog.**

Please read and understand this catalog before purchasing the products. Please consult your OMRON representative if you have any questions or comments.

## **Warranties.**

- (a) Exclusive Warranty. Omron's exclusive warranty is that the Products will be free from defects in materials and workmanship for a period of twelve months from the date of sale by Omron (or such other period expressed in writing by Omron). Omron disclaims all other warranties, express or implied.
- (b) Limitations. OMRON MAKES NO WARRANTY OR REPRESENTATION, EXPRESS OR IMPLIED, ABOUT NON-INFRINGEMENT, MERCHANTABILITY OR FITNESS FOR A PARTICULAR PURPOSE OF THE PRODUCTS. BUYER ACKNOWLEDGES THAT IT ALONE HAS DETERMINED THAT THE PRODUCTS WILL SUITABLY MEET THE REQUIREMENTS OF THEIR INTENDED USE.

Omron further disclaims all warranties and responsibility of any type for claims or expenses based on infringement by the Products or otherwise of any intellectual property right. (c) Buyer Remedy. Omron's sole obligation hereunder shall be, at Omron's election, to (i) replace (in the form originally shipped with Buyer responsible for labor charges for removal or replacement thereof) the non-complying Product, (ii) repair the non-complying Product, or (iii) repay or credit Buyer an amount equal to the purchase price of the non-complying Product; provided that in no event shall Omron be responsible for warranty, repair, indemnity or any other claims or expenses regarding the Products unless Omron's analysis confirms that the Products were properly handled, stored, installed and maintained and not subject to contamination, abuse, misuse or inappropriate modification. Return of any Products by Buyer must be approved in writing by Omron before shipment. Omron Companies shall not be liable for the suitability or unsuitability or the results from the use of Products in combination with any electrical or electronic components, circuits, system assemblies or any other materials or substances or environments. Any advice, recommendations or information given orally or in writing, are not to be construed as an amendment or addition to the abovewarranty.

See <http://www.omron.com/global/> or contact your Omron representative for published information.

## **Limitation on Liability; Etc.**

OMRON COMPANIES SHALL NOT BE LIABLE FOR SPECIAL, INDIRECT, INCIDENTAL, OR CONSEQUENTIAL DAMAGES, LOSS OF PROFITS OR PRODUCTION OR COMMERCIAL LOSS IN ANY WAY CONNECTED WITH THE PRODUCTS, WHETHER SUCH CLAIM IS BASED IN CONTRACT, WARRANTY, NEGLIGENCE OR STRICT LIABILITY.

Further, in no event shall liability of Omron Companies exceed the individual price of the Product on which liability is asserted.

## **Suitability of Use.**

Omron Companies shall not be responsible for conformity with any standards, codes or regulations which apply to the combination of the Product in the Buyer's application or use of the Product. At Buyer's request, Omron will provide applicable third party certification documents identifying ratings and limitations of use which apply to the Product. This information by itself is not sufficient for a complete determination of the suitability of the Product in combination with the end product, machine, system, or other application or use. Buyer shall be solely responsible for determining appropriateness of the particular Product with respect to Buyer's application, product or system. Buyer shall take application responsibility in all cases.

NEVER USE THE PRODUCT FOR AN APPLICATION INVOLVING SERIOUS RISK TO LIFE OR PROPERTY OR IN LARGE QUANTITIES WITHOUT ENSURING THAT THE SYSTEM AS A WHOLE HAS BEEN DESIGNED TO ADDRESS THE RISKS, AND THAT THE OMRON PRODUCT(S) IS PROPERLY RATED AND INSTALLED FOR THE INTENDED USE WITHIN THE OVERALL EQUIPMENT OR SYSTEM.

## **Programmable Products.**

Omron Companies shall not be responsible for the user's programming of a programmable Product, or any consequence thereof.

## **Performance Data.**

Data presented in Omron Company websites, catalogs and other materials is provided as a guide for the user in determining suitability and does not constitute a warranty. It may represent the result of Omron's test conditions, and the user must correlate it to actual application requirements. Actual performance is subject to the Omron's Warranty and Limitations of Liability.

## **Change in Specifications.**

Product specifications and accessories may be changed at any time based on improvements and other reasons. It is our practice to change part numbers when published ratings or features are changed, or when significant construction changes are made. However, some specifications of the Product may be changed without any notice. When in doubt, special part numbers may be assigned to fix or establish key specifications for your application. Please consult with your Omron's representative at any time to confirm actual specifications of purchased Product.

## **Errors and Omissions.**

Information presented by Omron Companies has been checked and is believed to be accurate; however, no responsibility is assumed for clerical, typographical or proofreading errors or omissions.

**Note: Do not use this document to operate the Unit.**

**OMRON Corporation Industrial Automation Company**  
Tokyo, JAPAN

**Contact: [www.ia.omron.com](http://www.ia.omron.com)**

**Regional Headquarters**

**OMRON EUROPE B.V.**

Wegalaan 67-69-2132 JD Hoofddorp  
The Netherlands

Tel: (31)2356-81-300/Fax: (31)2356-81-388

**OMRON ASIA PACIFIC PTE. LTD.**

No. 438A Alexandra Road # 05-05/08 (Lobby 2),  
Alexandra Technopark,  
Singapore 119967

Tel: (65) 6835-3011/Fax: (65) 6835-2711

**OMRON ELECTRONICS LLC**

One Commerce Drive Schaumburg,  
IL 60173-5302 U.S.A.

Tel: (1) 847-843-7900/Fax: (1) 847-843-7787

**OMRON (CHINA) CO., LTD.**

Room 2211, Bank of China Tower,  
200 Yin Cheng Zhong Road,  
PuDong New Area, Shanghai, 200120, China  
Tel: (86) 21-5037-2222/Fax: (86) 21-5037-2200

**Authorized Distributor:**

© OMRON Corporation 2009-2017 All Rights Reserved.  
In the interest of product improvement,  
specifications are subject to change without notice.  
CSM\_17\_1\_0120

**Cat. No. P061-E1-10**

1117 (0309)