

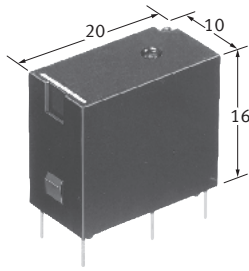

**!** Partly to Be Discontinued:  
10A type (Made in Thailand)  
Last time buy: September 30, 2016

### 1a/1c 5A/10A small power relays

# JQ RELAYS



### FEATURES

- High electrical noise immunity
- High switching capacity in a compact package
- High sensitivity: 200 mW (1a), 400 mW (1c)
- High surge voltage: 8,000 V between contacts and coil
- UL, CSA, VDE, SEMKO approved and TÜV available
- Class B coil insulation type also available.

### TYPICAL APPLICATIONS

- Air conditioners
- Refrigerators
- Microwave ovens
- Heaters

## ORDERING INFORMATION

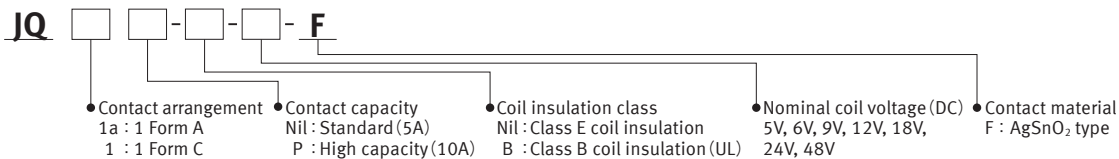

Note : Last order of made in Thailand JQ relay 10A type was the end of September, 2016.

## TYPES

### 1) Standard type

Nominal coil voltage	Standard type		High capacity type	
	1 Form A	1 Form C	1 Form A	1 Form C
	Part No.	Part No.	Part No.	Part No.
5 V DC	JQ1a-5V-F	JQ1-5V-F	JQ1aP-5V-F	JQ1P-5V-F
6 V DC	JQ1a-6V-F	JQ1-6V-F	JQ1aP-6V-F	JQ1P-6V-F
9 V DC	JQ1a-9V-F	JQ1-9V-F	JQ1aP-9V-F	JQ1P-9V-F
12 V DC	JQ1a-12V-F	JQ1-12V-F	JQ1aP-12V-F	JQ1P-12V-F
18 V DC	JQ1a-18V-F	JQ1-18V-F	JQ1aP-18V-F	JQ1P-18V-F
24 V DC	JQ1a-24V-F	JQ1-24V-F	JQ1aP-24V-F	JQ1P-24V-F
48 V DC	-	JQ1-48V-F	-	JQ1P-48V-F

Standard packing: Carton 100 pcs., Case 500 pcs.

## RATING

### 1. Coil data

- Operating characteristics such as 'Operate voltage' and 'Release voltage' are influenced by mounting conditions, ambient temperature, etc. Therefore, please use the relay within  $\pm 5\%$  of rated coil voltage.
- 'Initial' means the condition of products at the time of delivery.

Contact arrangement	Nominal coil voltage	Pick-up voltage (at 20°C)	Drop-out voltage (at 20°C)	Nominal operating current [ $\pm 10\%$ ] (at 20°C)	Coil resistance [ $\pm 10\%$ ] (at 20°C)	Nominal operating power (at 20°C)	Max. applied voltage
1 Form A	5 V DC	Standard type: 75%V or less of nominal voltage (Initial)	5%V or more of nominal voltage (Initial)	40.0 mA	125 $\Omega$	200 mW	180% of nominal voltage (at 20°C)
	6 V DC			33.3 mA	180 $\Omega$		
	9 V DC			22.2 mA	405 $\Omega$		
	12 V DC	High capacity type: 80%V or less of nominal voltage (Initial)		16.7 mA	720 $\Omega$		130% of nominal voltage (at 70°C) [When using relays at 85°C, see Notes*4]
	18 V DC			11.1 mA	1,620 $\Omega$		
	24 V DC			8.3 mA	2,880 $\Omega$		
1 Form C	5 V DC	Standard type: 75%V or less of nominal voltage (Initial)	5%V or more of nominal voltage (Initial)	80 mA	62.5 $\Omega$	400 mW	150% of nominal voltage (at 20°C)
	6 V DC			66.7 mA	90 $\Omega$		
	9 V DC			44.4 mA	202.5 $\Omega$		
	12 V DC	High capacity type: 80%V or less of nominal voltage (Initial)		33.3 mA	360 $\Omega$		110% of nominal voltage (at 70°C) [When using relays at 85°C, see Notes*4]
	18 V DC			22.2 mA	810 $\Omega$		
	24 V DC			16.7 mA	1,440 $\Omega$		
	48 V DC		8.3 mA	5,760 $\Omega$			

### 2. Specifications

Characteristics	Item	Specifications			
		Standard type		High capacity type	
Contact	Arrangement	1 Form A	1 Form C	1 Form A	1 Form C
	Contact resistance (Initial)	Max. 100 m $\Omega$ (By voltage drop 6 V DC 1 A)			
	Contact material	AgSnO <sub>2</sub> type			
Rating	Nominal switching capacity (resistive load)	5 A 125 V AC, 2 A 250 V AC, 5 A 30 V DC	N.O. side: 5 A 125 V AC, 2 A 250 V AC, 3 A 30 V AC N.C. side: 2 A 125 V AC, 1 A 250 V AC, 1 A 30 V DC	10 A 125 V AC, 5 A 250 V AC, 5 A 30 V DC	N.O. side: 10 A 125 V AC, 5 A 250 V AC, 5 A 30 V AC N.C. side: 3 A 125 V AC, 2 A 250 V AC, 1 A 30 V DC
	Max. switching power (resistive load)	625 VA, 150 W	N.O. side: 625 VA, 90 W N.C. side: 250 VA, 30 W	1,250 V AC, 150 W	N.O. side: 1,250 VA, 150 W N.C. side: 500 V AC, 30 W
	Max. switching voltage	250 V AC, 110 V DC (0.3 A)			
	Max. switching current	N.O.: 5 A, N.C.: 2 A		N.O.: 10 A, N.C.: 3 A	
	Nominal operating power	200 mW	400 mW	200 mW	400 mW
	Min. switching capacity (reference value)*1	100 mA, 5 V DC			
	Insulation resistance (Initial)	Min. 1,000 M $\Omega$ (at 500 V DC) Measurement at same location as "Breakdown voltage" section.			
Breakdown voltage (Initial)	Between open contacts	1,000 Vrms for 1 min.	750 Vrms for 1 min.	1,000 Vrms for 1 min.	750 Vrms for 1 min.
	Between contact and coil	4,000 Vrms for 1 min. (Detection current: 10 mA)			
Temperature rise (coil)	Max. 45°C (By resistive method, nominal coil voltage applied to the coil; contact carrying current: 5 A, at 70°C)		Max. 45°C (By resistive method, nominal coil voltage applied to the coil; contact carrying current: 10 A, at 70°C)		
Surge breakdown voltage*2 (Between contact and coil) (Initial)	8,000 V				
Operate time (at nominal voltage) (at 20°C) (Initial)	Max. 20 ms (excluding contact bounce time.)				
Release time (at nominal voltage) (at 20°C) (Initial)	Max. 10 ms (excluding contact bounce time) (Without diode)				
Mechanical characteristics	Shock resistance	Functional	294 m/s <sup>2</sup> (Half-wave pulse of sine wave: 11 ms; detection time: 10 $\mu$ s.)		
		Destructive	980 m/s <sup>2</sup> (Half-wave pulse of sine wave: 6 ms.)		
Vibration resistance	Functional	10 to 55 Hz at double amplitude of 1.6 mm (Detection time: 10 $\mu$ s.)			
	Destructive	10 to 55 Hz at double amplitude of 2.0 mm			
Expected life	Mechanical (at 180 times / min.)	Min. 10 <sup>7</sup>			
Conditions	Conditions for operation, transport and storage*3	Ambient temperature: -40°C to +70°C (class E insulation), -40°C to +85°C ** (class B insulation) Humidity: 5 to 85% R.H. (Not freezing and condensing at low temperature)			
	Max. operating speed	20 times / min. (at nominal switching capacity)			
Unit weight		Approx. 7 g			

\* Specifications will vary with foreign standards certification ratings.

Notes: \*1. This value can change due to the switching frequency, environmental conditions, and desired reliability level, therefore it is recommended to check this with the actual load.

\*2. Wave is standard shock voltage of  $\pm 1.2 \times 50 \mu$ s according to JEC-212-1981

\*3. The upper limit of the ambient temperature is the maximum temperature that can satisfy the coil temperature rise value. Refer to Usage, transport and storage conditions in NOTES.

\*4. When using relays in a high ambient temperature, consider the pick-up voltage rise due to the high temperature (a rise of approx. 0.4% V for each 1 °C with 20 °C as a reference) and use a coil impressed voltage that is within the maximum applied voltage range.

**3. Expected electrical life**

Type		Switching capacity	No. of operations	
Standard type	1 Form A	5 A 125 V AC	5×10 <sup>4</sup>	
		3 A 125 V AC	2×10 <sup>5</sup>	
	2 A 250 V AC	2×10 <sup>5</sup>		
	5 A 30 V DC	10 <sup>5</sup>		
1 Form C	N.O.	5 A 125 V AC	5×10 <sup>4</sup>	
		3 A 125 V AC	2×10 <sup>5</sup>	
	2 A 250 V AC	2×10 <sup>5</sup>		
	3 A 30 V DC	10 <sup>5</sup>		
N.C.	2 A 125 V AC	2×10 <sup>5</sup>		
	1 A 250 V AC	2×10 <sup>5</sup>		
1 A 30 V DC	10 <sup>5</sup>			
High capacity type	1 Form A	10 A 125 V AC	5×10 <sup>4</sup>	
		5 A 250 V AC	5×10 <sup>4</sup>	
		5 A 30 V DC	10 <sup>5</sup>	
	1 Form C	N.O.	10 A 125 V AC	5×10 <sup>4</sup>
			5 A 250 V AC	5×10 <sup>4</sup>
		5 A 30 V DC	10 <sup>5</sup>	
N.C.	3 A 125 V AC	2×10 <sup>5</sup>		
	2 A 250 V AC	2×10 <sup>5</sup>		
1 A 30 V DC	10 <sup>5</sup>			

**REFERENCE DATA**

1.-(1) Max. switching capacity (1 Form A type)

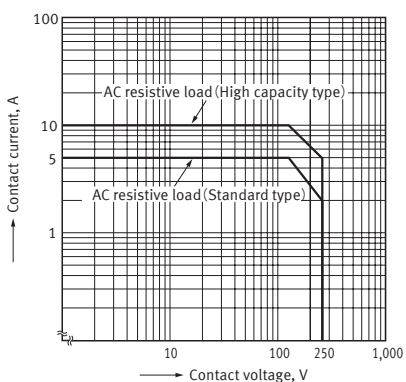

1.-(2) Max. switching capacity (1 Form C type)

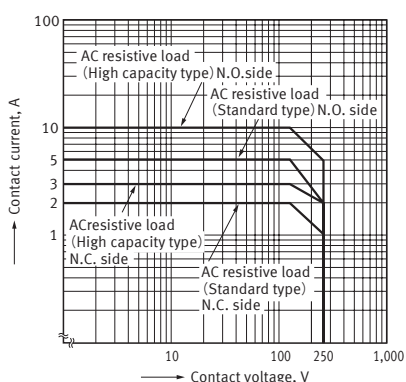

**Standard type**

2. Life curve

Ambient temperature : room temperature

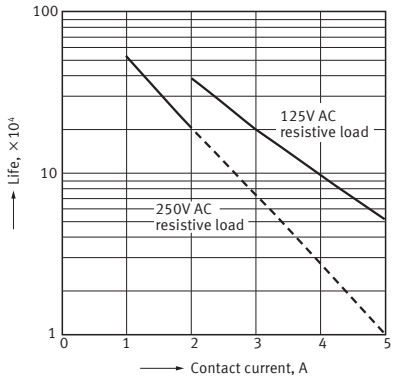

3.-(1) Operate & release time (1 Form A type)

Tested sample : JQ1-24V-F, 25 pcs.

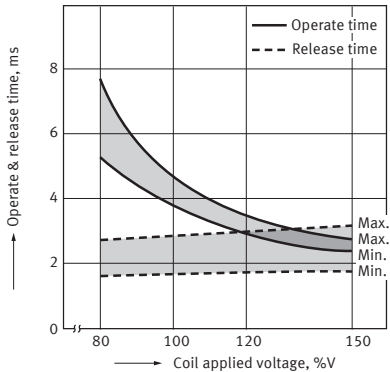

3.-(2) Operate & release time (1 Form C type)

Tested sample : JQ1-24V-F, 25 pcs.

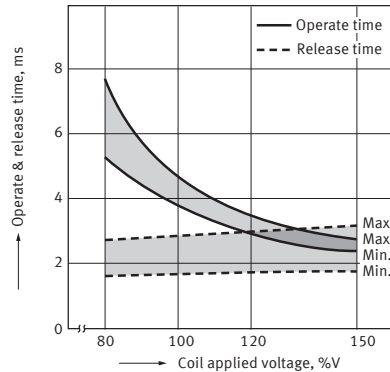

4.-(1) Coil temperature rise (1 Form A type)

Contact carrying current : 3 A, 5 A  
 Measured portion : Inside the coil

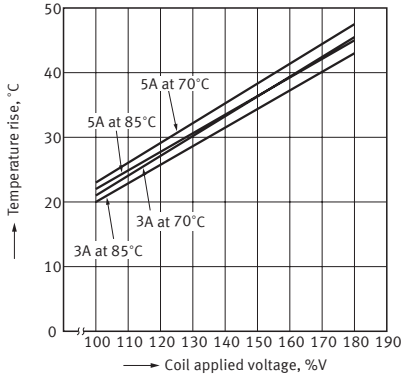

4.-(2) Coil temperature rise (1 Form C type)

Contact carrying current : 3 A, 5 A  
 Measured portion : Inside the coil

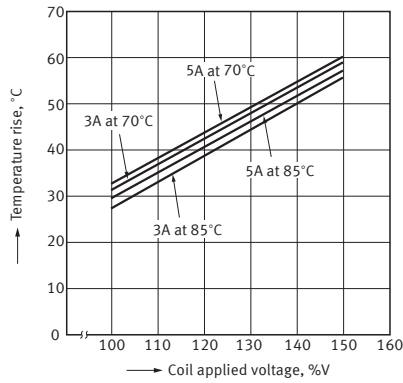

5.-(1) Ambient temperature characteristics (1 Form A type)

Tested sample : JQ1a-24V-F  
 Contact carrying current : 3 A, 5 A

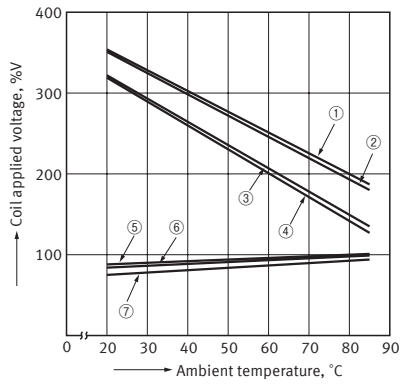

5.-(2) Ambient temperature characteristics (1 Form C type)

Tested sample : JQ1-24V-F  
 Contact carrying current : 3 A, 5 A

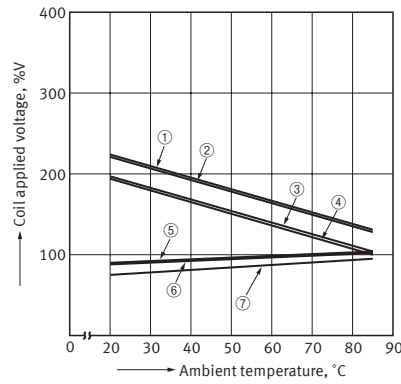

- ① Allowable ambient temperature against % coil voltage (max. inside the coil temperature set as 130 °C) (Carrying current: 3 A)
- ② Allowable ambient temperature against % coil voltage (max. inside the coil temperature set as 130 °C) (Carrying current: 5 A)
- ③ Allowable ambient temperature against % coil voltage (max. inside the coil temperature set as 115 °C) (Carrying current: 3 A)
- ④ Allowable ambient temperature against % coil voltage (max. inside the coil temperature set as 115 °C) (Carrying current: 5 A)
- ⑤ Pick-up voltage with a hot-start condition of 100%V on the coil (Carrying current: 5 A)
- ⑥ Pick-up voltage with a hot-start condition of 100%V on the coil (Carrying current: 3 A)
- ⑦ Pick-up voltage

High capacity type

1. Life curve

Ambient temperature : room temperature

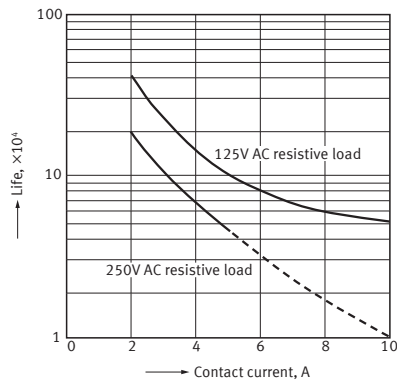

2.-(1) Operate & release time (1 Form A type)

Tested sample : JQ1aP-12V-F, 25 pcs.

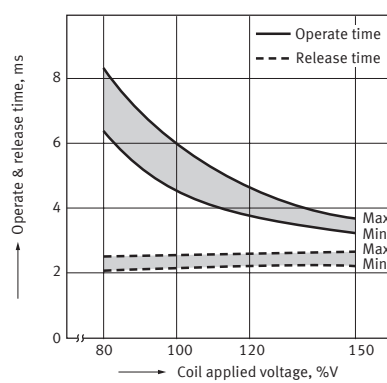

2.-(2) Operate & release time (1 Form C type)

Tested sample : JQ1P-12V-F, 25 pcs.

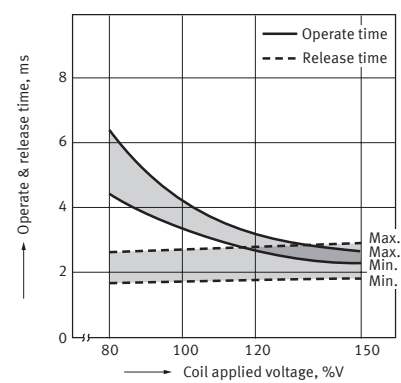

3.-(1) Coil temperature rise (1 Form A type)

Contact carrying current : 5 A, 10 A  
 Measured portion : Inside the coil

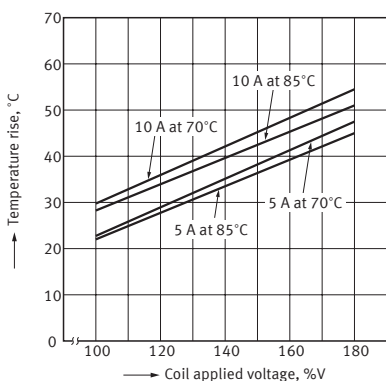

3.-(2) Coil temperature rise (1 Form C type)

Contact carrying current : 5 A, 10 A  
 Measured portion : Inside the coil

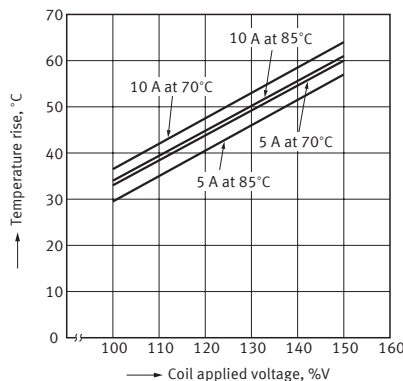

**4.-(1) Ambient temperature characteristics (1 Form A type)**

Tested sample : JQ1aP-24V-F  
 Contact carrying current : 5 A, 10 A

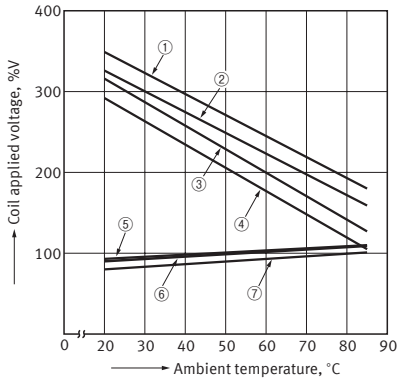

**4.-(2) Ambient temperature characteristics (1 Form C type)**

Tested sample : JQ1P-24V-F  
 Contact carrying current : 5 A, 10 A

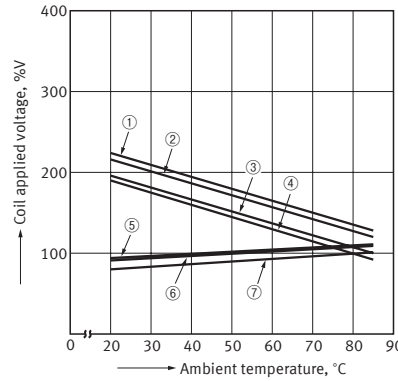

- ① Allowable ambient temperature against % coil voltage (max. inside the coil temperature set as 130 °C) (Carrying current: 5 A)
- ② Allowable ambient temperature against % coil voltage (max. inside the coil temperature set as 130 °C) (Carrying current: 10 A)
- ③ Allowable ambient temperature against % coil voltage (max. inside the coil temperature set as 115 °C) (Carrying current: 5 A)
- ④ Allowable ambient temperature against % coil voltage (max. inside the coil temperature set as 115 °C) (Carrying current: 10 A)
- ⑤ Pick-up voltage with a hot-start condition of 100%V on the coil (Carrying current: 10 A)
- ⑥ Pick-up voltage with a hot-start condition of 100%V on the coil (Carrying current: 5 A)
- ⑦ Pick-up voltage

**DIMENSIONS (mm)**

**CAD** The CAD data of the products with a "CAD" mark can be downloaded from our Website.

**CAD**

**External dimensions**

**Schematic (Bottom view)**

**1 Form A**

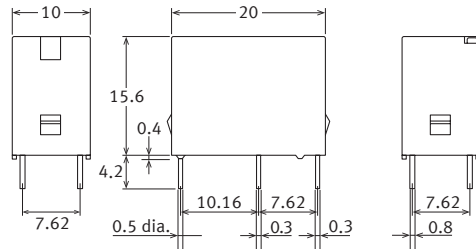

Dimension :  
 Less than 1mm : ±0.2  
 Min. 1mm less than 5mm : ±0.3  
 Min. 5mm : ±0.4

General tolerance  
 ±0.2  
 ±0.3  
 ±0.4

**1 Form A**

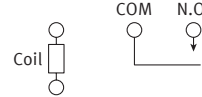

**1 Form C**

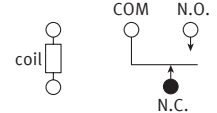

**PC board pattern (Bottom view)**

**1 Form C**

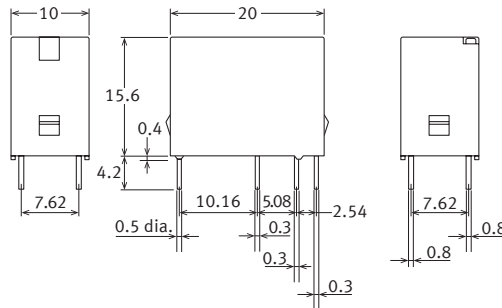

Dimension :  
 Less than 1mm : ±0.2  
 Min. 1mm less than 5mm : ±0.3  
 Min. 5mm : ±0.4

General tolerance  
 ±0.2  
 ±0.3  
 ±0.4

**1 Form A**

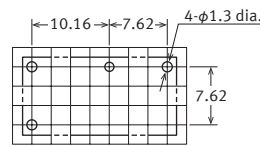

Tolerance : ±0.1

**1 Form C**

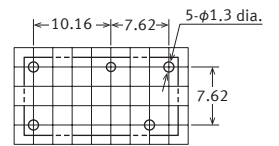

Tolerance : ±0.1



## SAFETY STANDARDS

Item	UL/C-UL (Recognized)		CSA (Certified)		VDE(Certified)		TÜV(Certified)		SEMKO(Certified)	
	File No.	Contact rating	File No.	Contact rating	File No.	Contact rating	File No.	Rating	File No.	Contact rating
Standard type (5A) 1 FormA	E43028	5A 125V AC 5A 277V AC 5A 30V DC 0.3A 110V DC 1/10HP 125V AC 1/6HP 277V AC	LR26550	5A 125V AC 5A 277V AC 5A 30V DC 0.3A 110V DC 1/10HP 125V AC 1/6HP 277V AC	40011435	5A 250V AC (cosφ =0.4)	B 11 04 13461 296	5A 250V AC (cosφ =0.4) 5A 30V DC (0ms)	817138	3(2)A 125V AC 2(1)A 250V AC 5A 30V DC
Standard type (5A) 1 FormC	E43028	5A 125V AC 5A 277V AC 5A 30V DC 0.3A 110V DC 1/10HP 125V AC 1/6HP 277V AC	LR26550	5A 125V AC 5A 277V AC 5A 30V DC 0.3A 110V DC 1/10HP 125V AC 1/6HP 277V AC	40011435	5A 250V AC (cosφ =0.4) (N.O.) 3A 250V AC (cosφ =0.4) (N.C.)	B 11 04 13461 296	5A 250V AC (cosφ =0.4) 5A 30V DC (0ms)	817138	3(2)A 125V AC 2(1)A 250V AC 5A 30V DC
High capacity type (10A) 1 FormA	E43028	10A 125V AC 8A 277V AC 5A 30V DC 0.3A 110V DC 1/6HP 125V AC 1/6HP 277V AC	LR26550	10A 125V AC 8A 277V AC 5A 30V DC 0.3A 110V DC 1/6HP 125V AC 1/6HP 277V AC	40011435	10A 250V AC (cosφ =0.4)	B 11 04 13461 296	10A 250V AC (cosφ =0.4) 5A 30V DC (0ms)	817138	5(3)A 250V AC 5A 30V DC
High capacity type (10A) 1 FormC	E43028	10A 125V AC 8A 277V AC 5A 30V DC 0.3A 110V DC 1/6HP 125V AC 1/6HP 277V AC	LR26550	10A 125V AC 8A 277V AC 5A 30V DC 0.3A 110V DC 1/6HP 125V AC 1/6HP 277V AC	40011435	(N.O.) 10A 250V AC (cosφ =0.4) (N.C.) 3A 250V AC (cosφ =0.4)	B 11 04 13461 296	10A 250V AC (cosφ =0.4) 5A 30V DC (0ms)	817138	5(3)A 250V AC 5A 30V DC

## NOTES

Note about relay installation orientation

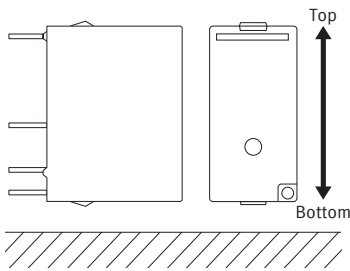

When installing with the relay terminals parallel to the ground, the contact terminals at the bottom and the coil terminals at the top, component friction will occur after numerous switching actions or due to vibration in the non-excitation state. Since this may cause the relay to stop functioning when the pick-up voltage increases even if the nominal voltage is applied, please do not install using this orientation.

## For Cautions for Use.

Please refer to **"the latest product specifications"** when designing your product.

•Requests to customers:

<https://industrial.panasonic.com/ac/e/salespolicies/>

# GUIDELINES FOR POWER RELAYS AND HIGH-CAPACITY DC CUT OFF RELAYS USAGE

For cautions for use, please read “GUIDELINES FOR RELAY USAGE”.

[https://industrial.panasonic.com/ac/e/control/relay/cautions\\_use/index.jsp](https://industrial.panasonic.com/ac/e/control/relay/cautions_use/index.jsp)

## Precautions for Coil Input

### ■ Long term current carrying

A circuit that will be carrying a current continuously for long periods without relay switching operation. (circuits for emergency lamps, alarm devices and error inspection that, for example, revert only during malfunction and output warnings with form B contacts) Continuous, long-term current to the coil will facilitate deterioration of coil insulation and characteristics due to heating of the coil itself.

For circuits such as these, please use a magnetic-hold type latching relay. If you need to use a single stable relay, use a sealed type relay that is not easily affected by ambient conditions and make a failsafe circuit design that considers the possibility of contact failure or disconnection.

### ■ DC Coil operating power

Steady state DC current should be applied to the coil. The wave form should be rectangular. If it includes ripple, the ripple factor should be less than 5%.

However, please check with the actual circuit since the electrical characteristics may vary. The rated coil voltage should be applied to the coil and the set/reset pulse time of latching type relay differs for each relays, please refer to the relay's individual specifications.

### ■ Coil connection

When connecting coils of polarized relays, please check coil polarity (+,-) at the internal connection diagram (Schematic). If any wrong connection is made, it may cause unexpected malfunction, like abnormal heat, fire and so on, and circuit do not work. Avoid impressing voltages to the set coil and reset coil at the same time.

## Ambient Environment

### ● Usage, Transport, and Storage Conditions

During usage, storage, or transportation, avoid locations subjected to direct sunlight and maintain normal temperature, humidity and pressure conditions.

### ● Temperature/Humidity/Pressure

When transporting or storing relays while they are tube packaged, there are cases the temperature may differ from the allowable range. In this case be sure to check the individual specifications. Also allowable humidity level is influenced by temperature, please check charts shown below and use relays within mentioned conditions. (Allowable temperature values differ for each relays, please refer to the relay's individual specifications.)

#### 1) Temperature:

The tolerance temperature range differs for each relays, please refer to the relay's individual specifications

#### 2) Humidity:

5 to 85 % RH

#### 3) Pressure:

86 to 106 kPa

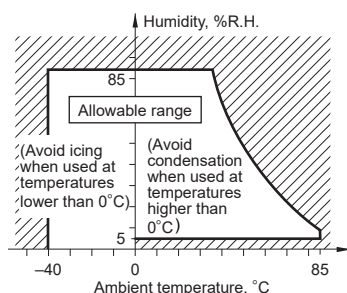

### ■ Maximum allowable voltage and temperature rise

Proper usage requires that the rated coil voltage be impressed on the coil. Note, however, that if a voltage greater than or equal to the maximum continuous voltage is impressed on the coil, the coil may burn or its layers short due to the temperature rise. Furthermore, do not exceed the usable ambient temperature range listed in the catalog.

### ■ Operate voltage change due to coil temperature rise (Hot start)

In DC relays, after continuous passage of current in the coil, if the current is turned OFF, then immediately turned ON again, due to the temperature rise in the coil, the pick-up voltage will become somewhat higher. Also, it will be the same as using it in a higher temperature atmosphere. The resistance/temperature relationship for copper wire is about 0.4% for 1°C, and with this ratio the coil resistance increases. That is, in order to operate of the relay, it is necessary that the voltage be higher than the pick-up voltage and the pick-up voltage rises in accordance with the increase in the resistance value. However, for some polarized relays, this rate of change is considerably smaller.

### ● Dew condensation

Condensation occurs when the ambient temperature drops suddenly from a high temperature and humidity, or the relay is suddenly transferred from a low ambient temperature to a high temperature and humidity. Condensation causes the failures like insulation deterioration, wire disconnection and rust etc. Panasonic Corporation does not guarantee the failures caused by condensation.

The heat conduction by the equipment may accelerate the cooling of device itself, and the condensation may occur.

Please conduct product evaluations in the worst condition of the actual usage. (Special attention should be paid when high temperature heating parts are close to the device. Also please consider the condensation may occur inside of the device.)

### ● Icing

Condensation or other moisture may freeze on relays when the temperature become lower than 0°C. This icing causes the sticking of movable portion, the operation delay and the contact conduction failure etc. Panasonic Corporation does not guarantee the failures caused by the icing.

The heat conduction by the equipment may accelerate the cooling of relay itself and the icing may occur. Please conduct product evaluations in the worst condition of the actual usage.

### ● Low temperature and low humidity

The plastic becomes brittle if the switch is exposed to a low temperature, low humidity environment for long periods of time.

### ● High temperature and high humidity

Storage for extended periods of time (including transportation periods) at high temperature or high humidity levels or in atmospheres with organic gases or sulfide gases may cause a sulfide film or oxide film to form on the surfaces of the contacts and/or it may interfere with the functions. Check out the atmosphere in which the units are to be stored and transported.



# GUIDELINES FOR POWER RELAYS AND HIGH-CAPACITY DC CUT OFF RELAYS USAGE

## ●Package

In terms of the packing format used, make every effort to keep the effects of moisture, organic gases and sulfide gases to the absolute minimum.

## ●Silicon

When a source of silicone substances (silicone rubber, silicone oil, silicone coating materials and silicone filling materials etc.) is used around the relay, the silicone gas (low molecular siloxane etc.) may be produced.

This silicone gas may penetrate into the inside of the relay. When the relay is kept and used in this condition, silicone compound may adhere to the relay contacts which may cause the contact failure. Do not use any sources of silicone gas around the relay (Including plastic seal types).

## ●NOx Generation

When relay is used in an atmosphere high in humidity to switch a load which easily produces an arc, the NOx created by the arc and the water absorbed from outside the relay combine to produce nitric acid. This corrodes the internal metal parts and adversely affects operation. Avoid use at an ambient humidity of 85%RH or higher (at 20°C). If use at high humidity is unavoidable, please contact our sales representative.

## Others

### ■Cleaning

- 1) Although the environmentally sealed type relay (plastic sealed type, etc.) can be cleaned, avoid immersing the relay into cold liquid (such as cleaning solvent) immediately after soldering. Doing so may deteriorate the sealing performance.
- 2) Cleaning with the boiling method is recommended(The temperature of cleaning liquid should be 40°C or lower ).  
Avoid ultrasonic cleaning on relays. Use of ultrasonic cleaning may cause breaks in the coil or slight sticking of the contacts due to ultrasonic energy.

Please refer to **"the latest product specifications"** when designing your product.

•Requests to customers:

<https://industrial.panasonic.com/ac/e/salespolicies/>



---

Please contact .....

**Panasonic Corporation**

Electromechanical Control Business Division

■1006, Oaza Kadoma, Kadoma-shi, Osaka 571-8506, Japan  
[industrial.panasonic.com/ac/e/](http://industrial.panasonic.com/ac/e/)

**Panasonic**<sup>®</sup>

©Panasonic Corporation 2019