



# GSE6-P1112

G6

MINIATURE PHOTOELECTRIC SENSORS

**SICK**  
Sensor Intelligence.



### Ordering information

Type	Part no.
GSE6-P1112	1052452

**Included in delivery:** BEF-W100-A (1)

Other models and accessories → [www.sick.com/G6](http://www.sick.com/G6)

Illustration may differ



### Detailed technical data

#### Features

<b>Sensor/ detection principle</b>	Through-beam photoelectric sensor
<b>Dimensions (W x H x D)</b>	12 mm x 31.5 mm x 21 mm
<b>Housing design (light emission)</b>	Rectangular
<b>Sensing range max.</b>	0 m ... 15 m
<b>Sensing range</b>	0 m ... 10 m
<b>Type of light</b>	Visible red light
<b>Light source</b>	PinPoint LED <sup>1)</sup>
<b>Light spot size (distance)</b>	Ø 375 mm (12 m)
<b>Wave length</b>	650 nm
<b>Adjustment</b>	None

<sup>1)</sup> Average service life: 100,000 h at T<sub>J</sub> = +25 °C.

#### Mechanics/electronics

<b>Supply voltage</b>	10 V DC ... 30 V DC <sup>1)</sup>
<b>Ripple</b>	± 10 % <sup>2)</sup>
<b>Current consumption</b>	30 mA <sup>3)</sup>

<sup>1)</sup> Limit values when operated in short-circuit protected network: max. 8 A.

<sup>2)</sup> May not exceed or fall below U<sub>v</sub> tolerances.

<sup>3)</sup> Without load.

<sup>4)</sup> At U<sub>v</sub> > 24 V, I<sub>A</sub> max. = 50 mA.

<sup>5)</sup> Signal transit time with resistive load.

<sup>6)</sup> With light/dark ratio 1:1.

<sup>7)</sup> Do not bend below 0 °C.

<sup>8)</sup> A = V<sub>S</sub> connections reverse-polarity protected.

<sup>9)</sup> B = inputs and output reverse-polarity protected.

<sup>10)</sup> D = outputs overcurrent and short-circuit protected.

<sup>11)</sup> Temperature stability following adjustment +/-10 °C.

<b>Switching output</b>	PNP
<b>Switching mode</b>	Light/dark switching
<b>Switching mode selector</b>	Selectable via light/dark selector
<b>Signal voltage PNP HIGH/LOW</b>	$V_S - (\leq 3 \text{ V}) / \text{ approx. } 0 \text{ V}$
<b>Output current <math>I_{\text{max}}</math></b>	$\leq 100 \text{ mA}^{4)}$
<b>Response time</b>	$< 500 \mu\text{s}^{5)}$
<b>Switching frequency</b>	$1,000 \text{ Hz}^{6)}$
<b>Connection type</b>	Cable, 3-wire, 2 m <sup>7)</sup>
<b>Cable material</b>	PVC
<b>Conductor cross-section</b>	$0.14 \text{ mm}^2$
<b>Circuit protection</b>	A <sup>8)</sup> B <sup>9)</sup> D <sup>10)</sup>
<b>Protection class</b>	III
<b>Weight</b>	170 g
<b>Housing material</b>	Plastic, ABS/PC
<b>Optics material</b>	Plastic, PMMA
<b>Enclosure rating</b>	IP67
<b>Items supplied</b>	Stainless steel mounting bracket (1.4301/304) BEF-W100-A
<b>Ambient operating temperature</b>	$-25 \text{ }^\circ\text{C} \dots +55 \text{ }^\circ\text{C}^{11)}$
<b>Ambient storage temperature</b>	$-40 \text{ }^\circ\text{C} \dots +70 \text{ }^\circ\text{C}$
<b>UL File No.</b>	NRKH.E348498 & NRKH7.E348498

1) Limit values when operated in short-circuit protected network: max. 8 A.

2) May not exceed or fall below  $U_V$  tolerances.

3) Without load.

4) At  $U_V > 24 \text{ V}$ ,  $I_A \text{ max.} = 50 \text{ mA}$ .

5) Signal transit time with resistive load.

6) With light/dark ratio 1:1.

7) Do not bend below  $0 \text{ }^\circ\text{C}$ .

8) A =  $V_S$  connections reverse-polarity protected.

9) B = inputs and output reverse-polarity protected.

10) D = outputs overcurrent and short-circuit protected.

11) Temperature stability following adjustment  $\pm 10 \text{ }^\circ\text{C}$ .

## Safety-related parameters

<b>MTTF<sub>D</sub></b>	1,085 years
<b>DC<sub>avg</sub></b>	0%

## Classifications

<b>ECl@ss 5.0</b>	27270901
<b>ECl@ss 5.1.4</b>	27270901
<b>ECl@ss 6.0</b>	27270901
<b>ECl@ss 6.2</b>	27270901
<b>ECl@ss 7.0</b>	27270901
<b>ECl@ss 8.0</b>	27270901

<b>ECl@ss 8.1</b>	27270901
<b>ECl@ss 9.0</b>	27270901
<b>ECl@ss 10.0</b>	27270901
<b>ECl@ss 11.0</b>	27270901
<b>ETIM 5.0</b>	EC002716
<b>ETIM 6.0</b>	EC002716
<b>ETIM 7.0</b>	EC002716
<b>UNSPSC 16.0901</b>	39121528

### Connection diagram

Cd-049

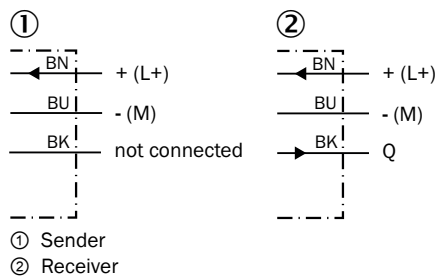

### Characteristic curve

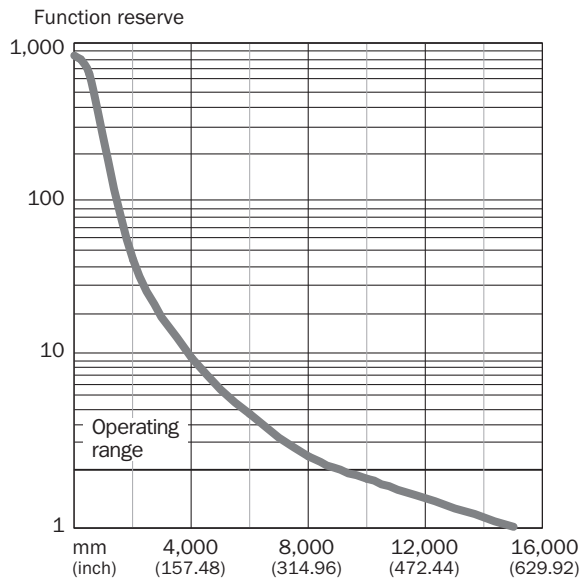

### Light spot size

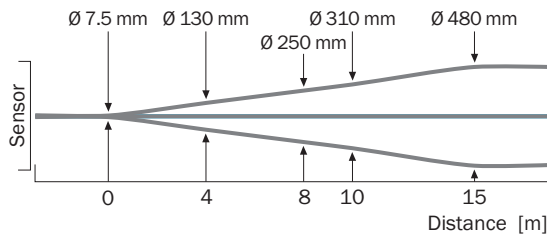

### Sensing range diagram

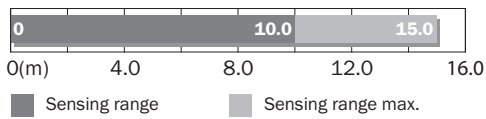

### Adjustments possible

No adjustment possibility

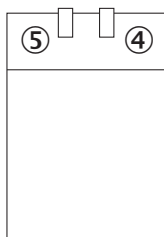

- ④ LED indicator green: Supply voltage active
- ⑤ LED indicator yellow: Status of received light beam

### Dimensional drawing (Dimensions in mm (inch))

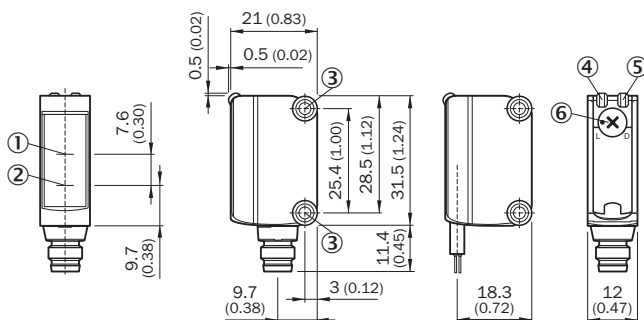

- ① Optical axis, receiver
- ② Optical axis, sender
- ③ Mounting holes M3
- ④ LED indicator green: Supply voltage active
- ⑤ LED indicator yellow: Status of received light beam
- ⑥ Light/ dark rotary switch: L = light switching, D = dark switching

### Recommended accessories

Other models and accessories → [www.sick.com/G6](http://www.sick.com/G6)

	Brief description	Type	Part no.
Plug connectors and cables			
	Head A: male connector, M8, 3-pin, straight Head B: - Cable: unshielded	STE-0803-G	6037322

## SICK AT A GLANCE

SICK is one of the leading manufacturers of intelligent sensors and sensor solutions for industrial applications. A unique range of products and services creates the perfect basis for controlling processes securely and efficiently, protecting individuals from accidents and preventing damage to the environment.

We have extensive experience in a wide range of industries and understand their processes and requirements. With intelligent sensors, we can deliver exactly what our customers need. In application centers in Europe, Asia and North America, system solutions are tested and optimized in accordance with customer specifications. All this makes us a reliable supplier and development partner.

Comprehensive services complete our offering: SICK LifeTime Services provide support throughout the machine life cycle and ensure safety and productivity.

For us, that is “Sensor Intelligence.”

## WORLDWIDE PRESENCE:

Contacts and other locations –[www.sick.com](http://www.sick.com)