

Solid State Relays

G3RV

Slimmest OMRON plug-in SSR with maximum width 6.2 mm

- Long electrical life and high speed switching
- Large plug-in terminals for reliable connection
- G3RV-D (DC load) models can manage resistive loads of 100 μ A to 3.0 A
- LED indicator for visible operation checking
- Convenient quick electrical connections possible with G3RV push-in models and cross bar connectors
- Low power consumption for energy savings
- G3RV is cUL listed when correct relay is matched with the G3RV Socket

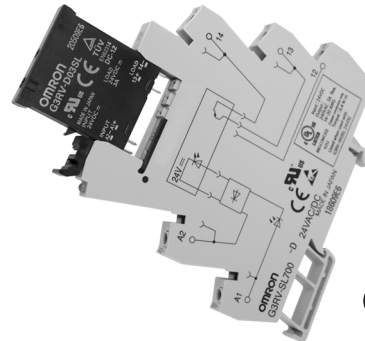

Model Number Structure

Model Number Legend

G3RV-SL -

1 2 3 4

1. Basic Model Name

G3RV: Solid State Relay

2. Auxiliary Type Designation

SL: Slim Solid State Relay and socket combination

3. Wire Connection

700: Screw Terminals

500: Push-in (screwless) terminals

4. Output voltage specifications

A(L): AC Output .. TRIAC

*A: with Zero cross function AL: without Zero cross function

D: DC Output .. MOS FET

Ordering Information

List of Models

Classification		Enclosure rating	Input voltage	Type of connection	Contact form
Plug-in terminals	General-purpose				SPST
		Unsealed	AC/DC	Screw terminals	G3RV-SL700
				Push-in terminals	G3RV-SL500

SSR and Socket Combinations

Input voltage	Screw terminals	Push-in terminals
12 VDC	G3RV-SL700-D 12VDC	G3RV-SL500-D 12VDC
	G3RV-SL700-A(L) 12VDC	G3RV-SL500-A(L) 12VDC
24 VDC	G3RV-SL700-D 24VDC	G3RV-SL500-D 24VDC
	G3RV-SL700-A(L) 24VDC	G3RV-SL500-A(L) 24VDC
24 VAC/DC	G3RV-SL700-D 24VAC/DC	G3RV-SL500-D 24VAC/DC
	G3RV-SL700-A(L) 24VAC/DC	G3RV-SL500-A(L) 24VAC/DC
48 VAC/DC	G3RV-SL700-D 48VAC/DC	G3RV-SL500-D 48VAC/DC
	G3RV-SL700-A(L) 48VAC/DC	G3RV-SL500-A(L) 48VAC/DC
110 VAC	G3RV-SL700-D 110VAC	G3RV-SL500-D 110VAC
	G3RV-SL700-A(L) 110VAC	G3RV-SL500-A(L) 110VAC
230 VAC	G3RV-SL700-D 230VAC	G3RV-SL500-D 230VAC
	G3RV-SL700-A(L) 230VAC	G3RV-SL500-A(L) 230VAC

Specifications

■ Ratings (at an Ambient Temperature of 25°C)

Input

G3RV-SL700/500-A Series

Rated voltage	Rated current			Must operate voltage	Must release voltage	Input voltage % of rated voltage
	AC		DC			
	50 Hz	60 Hz				
12 VDC	---	---	15 mA	10.8V	1V	±10%
24 VDC	---	---	12 mA	21.6V		
24 VAC/DC	20 mA	21 mA	11 mA	21.6V		
48 VAC/DC	10 mA	11 mA	6 mA	43.2V		
110 VAC	7.5 mA	8.2 mA	---	99V		
230 VAC	7.3 mA	8.6 mA	---	207V		

G3RV-SL700/500-AL Series

Rated voltage	Rated current			Must operate voltage	Must release voltage	Input voltage % of rated voltage
	AC		DC			
	50 Hz	60 Hz				
12 VDC	---	---	15 mA	10.8V	1V	±10%
24 VDC	---	---	12 mA	21.6V		
24 VAC/DC	20 mA	21 mA	11 mA	21.6V		
48 VAC/DC	10 mA	11 mA	6 mA	43.2V		
110 VAC	7.5 mA	8.2 mA	---	99V		
230 VAC	7.3 mA	8.6 mA	---	207V		

G3RV-SL700/500-D Series

Rated voltage	Rated current			Must operate voltage	Must release voltage	Input voltage % of rated voltage
	AC		DC			
	50 Hz	60 Hz				
12 VDC	---	---	8 mA	10.8V	1V	±10%
24 VDC	---	---	4.5 mA	21.6V		
24 VAC/DC	10.7 mA	11.1 mA	4.3 mA	21.6V		
48 VAC/DC	9.6 mA	10.2 mA	6 mA	43.2V		
110 VAC	6.8 mA	7.5 mA	---	99V		
230 VAC	6.8 mA	8.1 mA	---	207V		

Output

Item	G3RV-SL700/500-A(L)	G3RV-SL700/500-D
Rated load voltage	AC100 to 240V (50/60Hz)	DC5 to 24V
Load voltage range	AC75 to 264V (50/60Hz)	DC3 to 26.4V
Load current	0.1 to 2A (Ta=40°C)	100μA to 3A (Ta=40°C)
Inrush current	30A (60Hz/1cycle)	30A (60Hz/1cycle)
Permissible I ² t ; Joule Integral (Reference value)	15A ² s	9A ² s
Application load capacity	400W (Output voltage: AC200V)	72W (Output voltage: DC24V)

■ Characteristics

Item	G3RV-SL700/500-A	G3RV-SL700/500-AL	G3RV-SL700/500-D
Operate time	1/2 of load power source cycle + 1 ms max.	1 ms max.	6 ms max.
Release time	40 ms max.	20 ms max.	60 ms max.
Output ON voltage drop	1.6 V rms max.		0.9 V max.
Leakage current	5 mA max. (at 200 VAC 50/60Hz)		10 μA max. (at 24VDC)
Insulation resistance	100 MΩ min. (at 500 VDC)		
Dielectric strength	AC2500V 50/60 Hz for 1 min between input and output		
Vibration resistance	Malfunction: 10 to 55 to 10 Hz, 0.7-mm single amplitude		
Shock resistance	300m/s ²		
Ambient temperature	Storage: -30 to +100°C (with no icing or condensation) Operating: -30 to +55°C (with no icing or condensation)		
Ambient humidity	45 to 85%RH		
Weight	Approx. 38 g		
Pollution degree	2		
Degree of protection according to IEC 60529	IP20		
Rated Impulse Withstand Voltage	4.0kV / III		
Load category	LC-A		DC-12
Overload Current Profile	1.5Ie 1.1I _e 5s ON, 10s OFF, 10cycles		
Rated insulation Voltage	240V		

■ Approved Standards

UL 508 (File No. E64562)

Model	Input ratings	Contact ratings
G3RV-SL700/500-D Series	12, 24 VDC 24, 48 VAC/DC 110, 230 VAC	24 VDC 3 A (Resistive Load) at 25°C
G3RV-SL700/500-A(L) Series	12, 24 VDC 24, 48 VAC/DC 110, 230 VAC	240 VAC 2 A (Resistive Load) at 25°C

IEC/TUV (EN 62314)

Input ratings	Contact ratings
12, 24 VDC 24, 48 VAC/DC 110, 230 VAC	24 VDC 3 A (Resistive Load)
12, 24 VDC 24, 48 VAC/DC 110, 230 VAC	240 VAC 2 A (Resistive Load)

Engineering Data

■ Load current derating curves

G3RV-SL700/500-A(L) Series

Mounting Distance 10mm

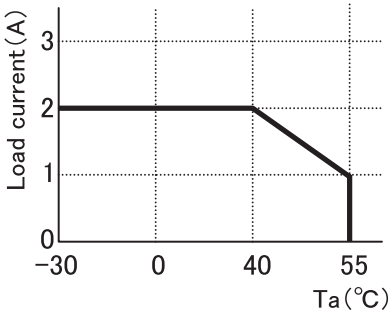

Mounting Distance 0mm

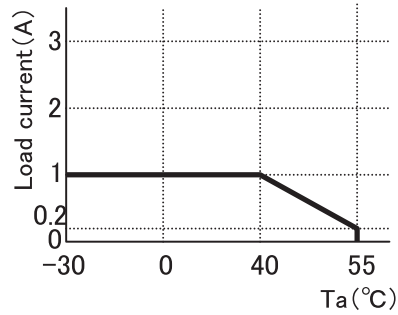

G3RV-SL700/500-D Series

Mounting Distance 10mm

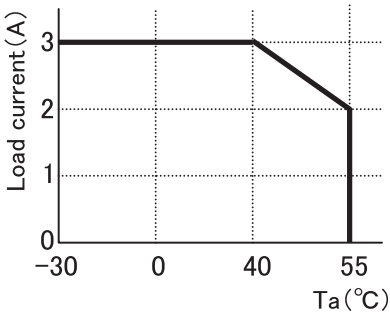

Mounting Distance 0mm

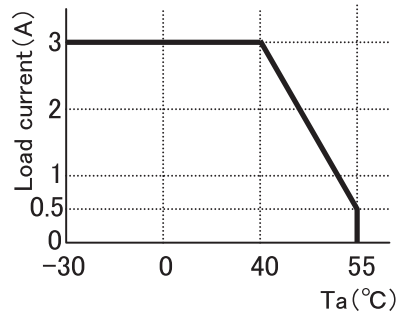

■ One Cycle Surge Current: Non-repetitive

Non-repetitive (Keep the inrush current to half the rated value if it occurs repetitively.)

The values shown by the solid line are for non-repetitive inrush currents.

G3RV-SL700/500-A(L) Series

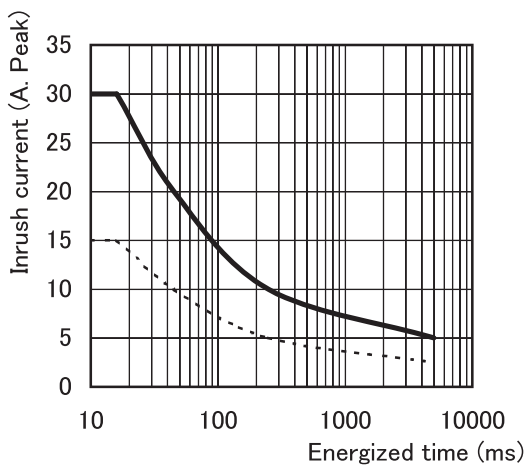

G3RV-SL700/500-D Series

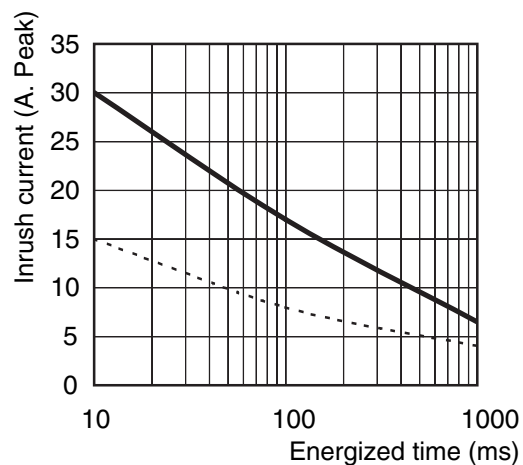

Accessories

■ PLC Interface (for G2RV-SL700 & G3RV-SL700 series only)

List of Models

Model number	Description	Connection
P2RVC-8-O-F	PLC Output Interface for 8x G2RV-SL700 & G3RV-SL700 series PNP - type	Ribbon cable connector 10 Pole, IEC603/1

Specifications

Input	Rated voltage	30 VAC/VDC max.
	Current capacity	0.5 A per channel 2.0 A total current, power supply terminal
	Characteristics	Ambient temperature Operating: 0 to 55°C Storage: - 20 to 85°C
	Overvoltage category	III
	Pollution degree	2

Electrical schematic P2RVC-O-8-F

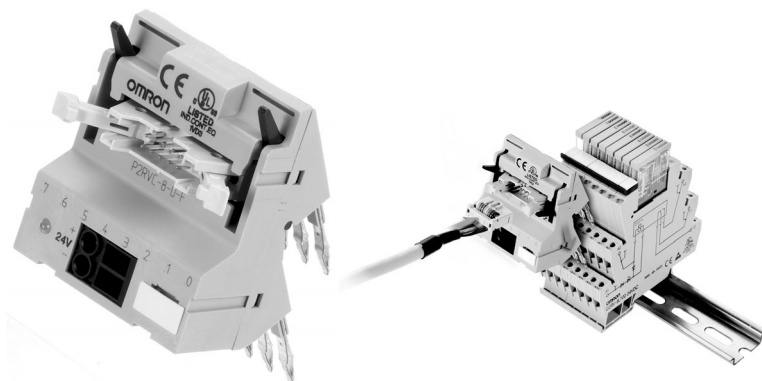
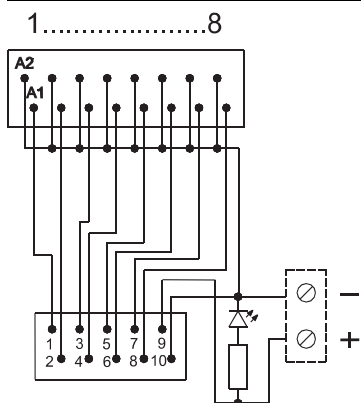

■ SSR for Maintenance (Replacement SSRs)

Model Number Legend

G3RV-□ □ □ □
1 2 3 4

1. Output voltage specifications

- D: DC Output
- 2: AC Output

2. Rated Current

- 02: AC Output 2A
- 03: DC Output 3A

3. Terminals

- S: Plug-In

4. Zero cross function

- Blank: with Zero cross function
- L: without Zero cross function

List of Models

Isolation	Movement indication	Rated input voltage (Socket)	Output (SSR)	Zero cross function	Rated output load*	Model Number	Replacement for						
Phototriac	Yes (Green)	DC12V	AC	Yes	2A at 100 to 240VAC	G3RV-202S DC12	G3RV-SL700/500-A DC12						
						G3RV-202S DC24	G3RV-SL700/500-A DC24						
						AC/DC24V	G3RV-SL700/500-A AC/DC24						
						AC/DC48V	G3RV-SL700/500-A AC/DC48						
						AC110V	G3RV-202S DC48	G3RV-SL700/500-A AC110					
						AC230V	G3RV-SL700/500-A AC230						
		DC12V		No		DC24V	G3RV-202SL DC12	G3RV-SL700/500-AL DC12					
						AC/DC24V	G3RV-202SL DC24	G3RV-SL700/500-AL DC12					
						AC/DC48V		G3RV-SL700/500-AL AC/DC24					
						AC110V		G3RV-SL700/500-AL AC/DC48					
						AC230V	G3RV-202SL DC48	G3RV-SL700/500-AL AC110					
								G3RV-SL700/500-AL AC230					
						Photocoupler		DC12V	DC	---	3A at 5 to 24 VDC	G3RV-D03SL DC12	G3RV-SL700/500-D DC12
												G3RV-D03SL DC24	G3RV-SL700/500-D DC24
AC/DC24V	G3RV-SL700/500-D AC/DC24												
AC/DC48V	G3RV-D03SL DC48	G3RV-SL700/500-D AC/DC48											
AC110V		G3RV-SL700/500-D AC110											
AC230V		G3RV-SL700/500-D AC230											

*different by ambient temperature.

Please refer to 4 pages of characteristic data " ■ Load current derating curves" for the details.



■ Cross bars

Model Number Legend

P2RVM -
 1 2

1. Number of Poles

- 020: 2 poles
- 030: 3 poles
- 040: 4 poles
- 100: 10 poles
- 200: 20 poles

2. Color

- R: Red
- S: Blue
- B: Black

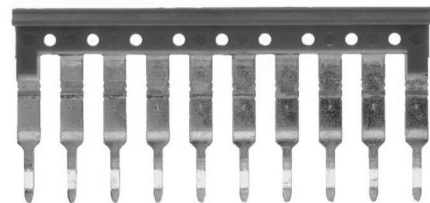
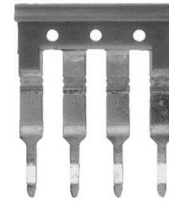

List of Models

Model number	Poles	Quantity	Color
P2RVM-020 <input type="checkbox"/>	2	60 pcs / box (minimum order)	Red (R) Blue (S) Black (B)
P2RVM-030 <input type="checkbox"/>	3	60 pcs / box (minimum order)	
P2RVM-040 <input type="checkbox"/>	4	60 pcs / box (minimum order)	
P2RVM-100 <input type="checkbox"/>	10	20 pcs / box (minimum order)	
P2RVM-200 <input type="checkbox"/>	20	20 pcs / box (minimum order)	

select color: R = Red, S = Blue, B = Black

Specification

Max current (EN60947-7-1 section 8.3.3 / 1991)	32A
Max. Voltage	400 VAC
Max. Voltage when cutting Cross-bar without using separation plate or end-bracket	250 VAC

■ Plastic Labels for G2RV/G3RV Sockets

Model number	Box quantity	Color
R99-15 for G2RV	5 sheets × 120 labels = 600 labels (minimum order)	White

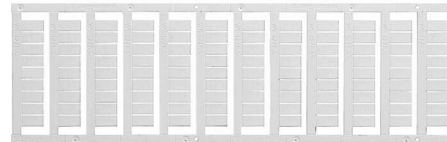

■ Labels (Stickers) for G2RV/G3RV Sockets

Model number	Box quantity	Color
R99-16 for G2RV	10 sheets × 484 labels = 4,840 labels (minimum order)	White



■ Separating Plates

Model number	Quantity	Description
P2RV-S	50 plates	Provides isolation between adjacent relays to achieve 400 V isolation.

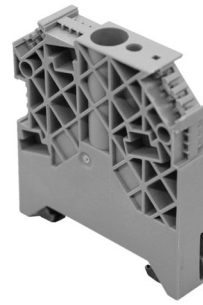

Dimensions

Note: All units are in millimeters unless otherwise indicated.

Complete Unit

G3RV-SL700

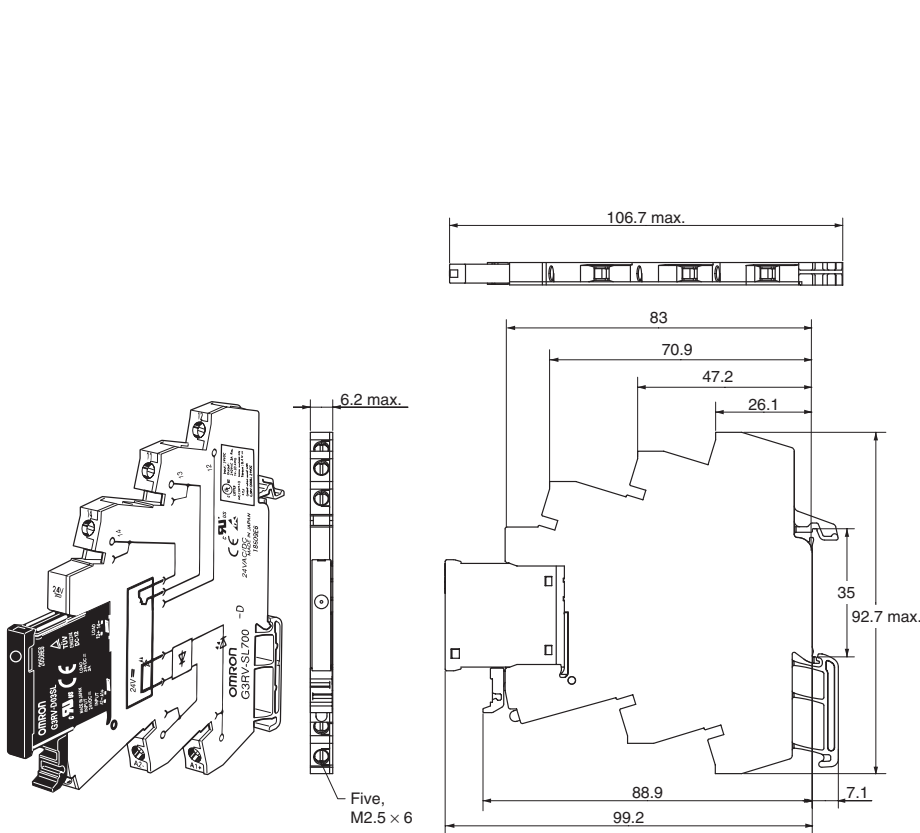

Input circuit

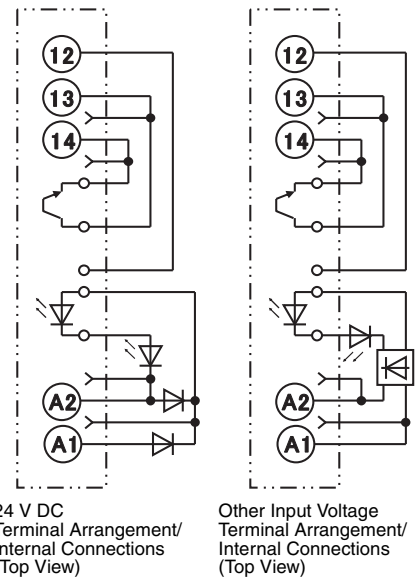

24 V DC Terminal Arrangement/ Internal Connections (Top View)

Other Input Voltage Terminal Arrangement/ Internal Connections (Top View)

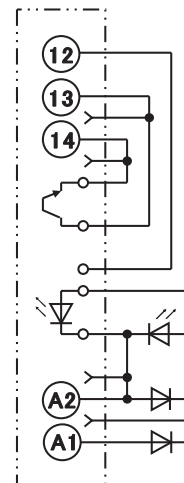

12 V DC Terminal Arrangement/ Internal Connections (Top View)

G3RV-SL500

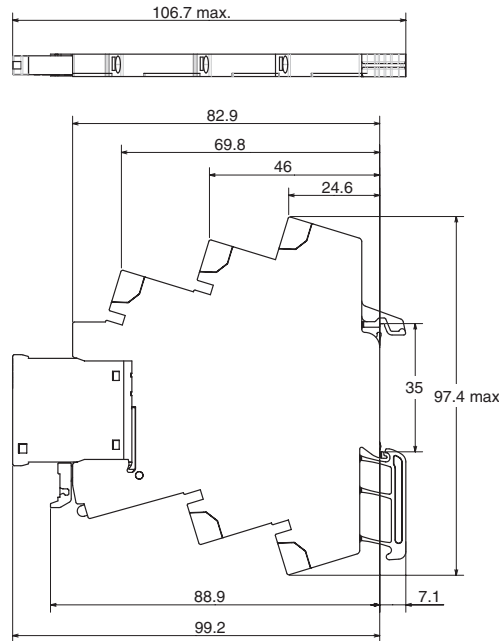
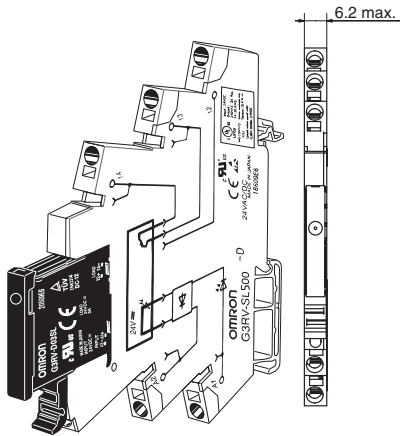

Input circuit

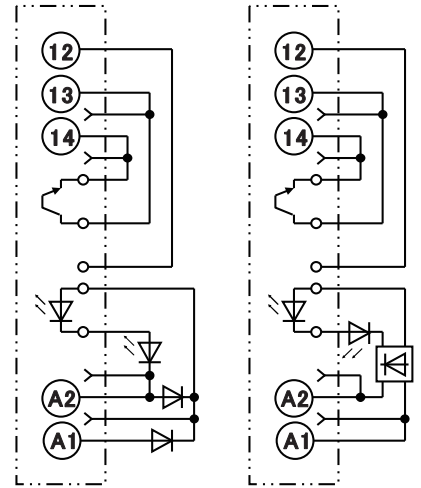

24 V DC
Terminal Arrangement/
Internal Connections
(Top View)

Other Input Voltage
Terminal Arrangement/
Internal Connections
(Top View)

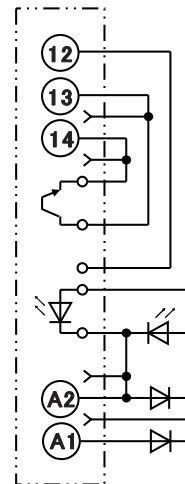

12 V DC
Terminal Arrangement/
Internal Connections
(Top View)

Solid State Relay

G3RV-D03SL
G3RV-202S(L)

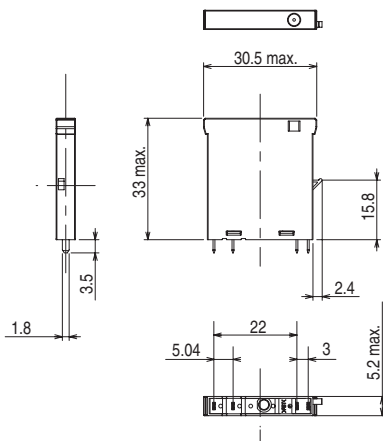

Input circuit
G3RV-D03SL

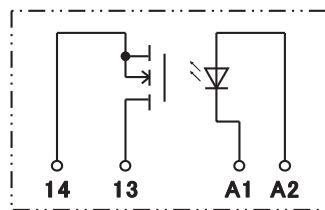

G3RV-202S(L)

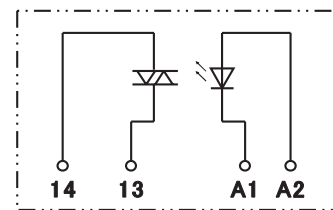

Terminal Arrangement/
Internal Connections
(Bottom View)

Installation

■ Tools

G3RV-SL700 series: Flat-Blade screwdriver should be used for mounting and / or releasing cables.

G3RV-SL500 series: Flat-Blade screwdriver should be used for mounting stranded wires without ferrules and / or releasing cables.

Applicable Screwdriver

- Flat-blade, Parallel-tip, 2.5 mm diameter (3.0 mm max.)

- Flat-blade, Parallel-tip



2.5 dia. (3.0 mm max.)

- Flat-blade, Flared-tip

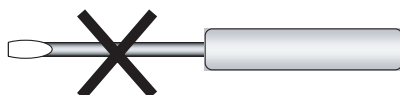

Cannot be used.

Examples: FACOM AEF.2.5 × 75E (AEF. 3 × 75E)
 VESSEL No. 9900-(-)2.5 × 75 (No. 9900-(-)3 × 100)
 WAGO 210-119
 WIHA 260/2.5 × 40 (260/3 × 50)

*Chamfering the tip of the driver improves insertion when used as an exclusive tool.

■ Applicable Wires

Applicable Wire Sizes

G3RV-SL700 Series

Box clamp technology

Wire type	Applicable wire size	Stripping length
Stranded without ferrules	0.5 - 1.5 mm ²	7 mm
Stranded with ferrules and plastic collar	0.5 - 1.5 mm ²	7 mm
Stranded with ferrules without plastic collar	0.5 - 1.5 mm ²	7 mm
Solid	0.5 - 1.5 mm ²	7 mm

G3RV-SL500 Series

Push-in technology

Wire type	Applicable wire size	Stripping length
Stranded without ferrules	0.5 - 1.5 mm ²	12 mm
Stranded with ferrules and plastic collar	0.5 - 1.5 mm ²	12 mm
Stranded with ferrules without plastic collar	0.5 - 1.5 mm ²	12 mm
Solid	0.5 - 1.5 mm ²	12 mm

Tightening torque

G3RV-SL700 Series: 0.4Nm

■ Wiring

Use wires of the applicable sizes specified above. The length of the exposed conductor should be 7 mm for a G3RV-SL700 series, 12 mm for a G3RV-SL500 series.

G3RV-SL700

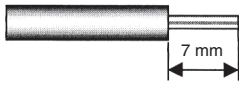

G3RV-SL500

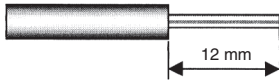
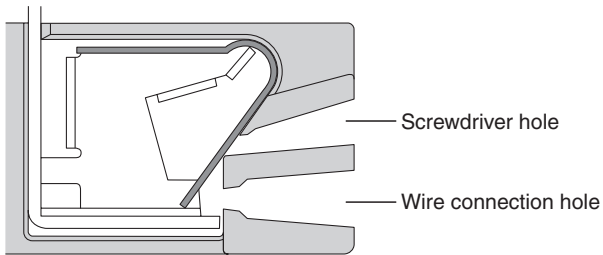
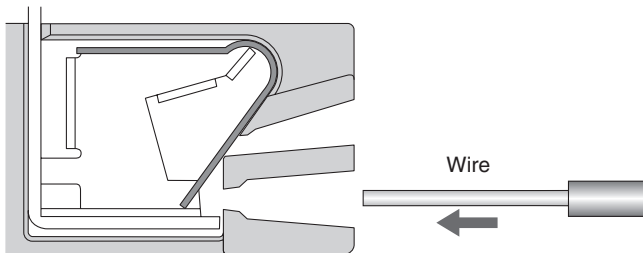

Fig. 1 Exposed Conductor Length

Wiring Procedure for G3RV-SL500 series



● Wiring



Insert the exposed conductor into the connection hole.

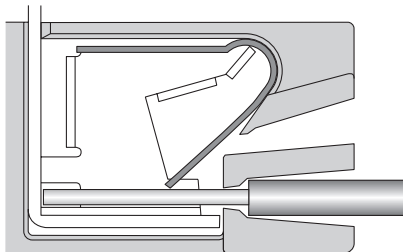

No other tools are required.

Note: In case of wiring stranded wires without ferrules screwdriver should be inserted before inserting the wire.
Screwdriver should be removed after fully insertion of the wire.

● Removing

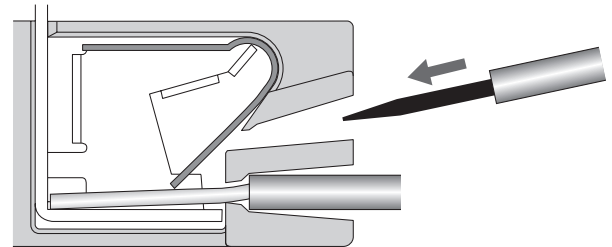

Insert the specified screwdriver into the release hole.

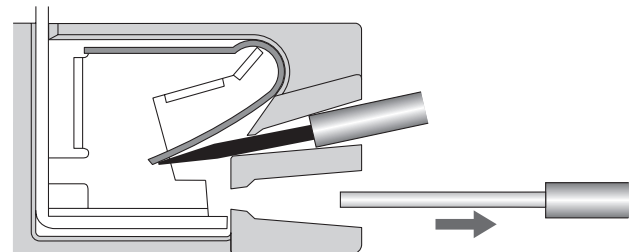

Removing wire.

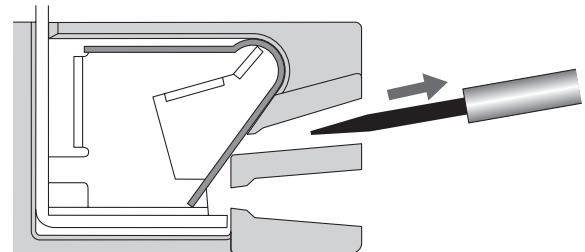

Removing screwdriver.

Precautions

Precautions for Connection

- Do not move the screwdriver up, down, or from side to side while it is inserted in the hole. Doing so may cause damage to internal components (e.g., deformation of the clamp spring or cracks in the housing) or cause deterioration of insulation.
- Do not insert the screwdriver at an angle. Doing so may break the side of socket and result in a short-circuit.

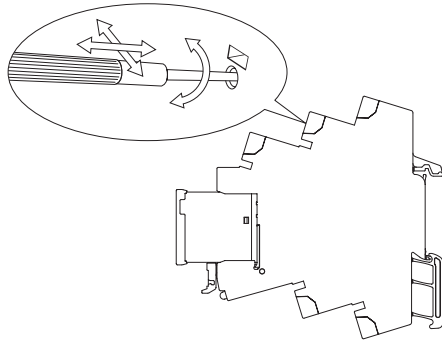

- Do not insert two or more wires in the hole. Wires may come in contact with the spring causing a temperature rise or be subject to sparks.

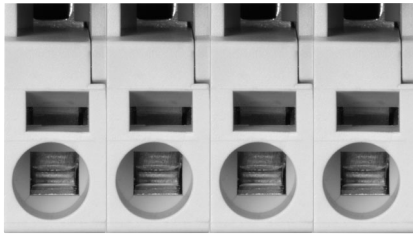

- Insert the screwdriver along the hole wall as shown below.

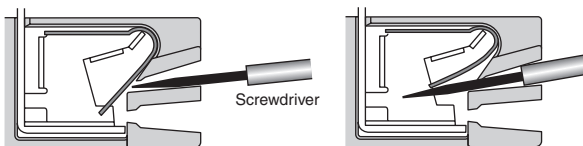

- If lubricating liquid, such as oil, is present on the tip of screwdriver, the screwdriver may fall out resulting in injury to the operator.
- Insert the screwdriver into the bottom of the hole. It may not be possible to connect cables properly if the screwdriver is inserted incorrectly.

General Precautions

- Do not use the product if it has been dropped on the ground. Dropping the product may adversely affect performance.
- Confirm that the socket is securely attached to the mounting track before wiring. If the socket is mounted insecurely it may fall and injure the operator.
- Ensure that the socket is not charged during wiring and maintenance. Not doing so may result in electric shock.
- Do not pour water or cleansing agents on the product. Doing so may result in electric shock.
- Do not use the socket in locations subject to solvents or alkaline chemicals.
- Do not use the socket in locations subject to ultraviolet light (e.g., direct sunlight). Doing so may result in markings fading, rust, corrosion, or resin deterioration.
- Do not dispose the product in fire.

Removing from Mounting Rail



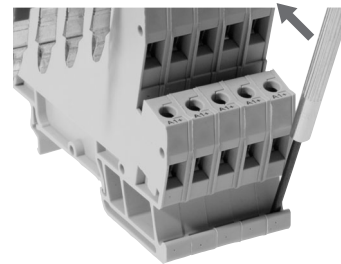

To remove the socket from the mounting rail, insert the tip of screwdriver in the fixture rail, and move it in the direction shown below.



Definition of Precautionary Information

⚠ WARNING	Indicates a potentially hazardous situation which, if not avoided, will result in minor or moderate injury, or may result in serious injury or death. Additionally there may be significant property damage.
------------------	--

⚠ CAUTION	A potentially hazardous situation by misuse, may result in property damage only accident.
------------------	---

⚠ CAUTION	
Minor hazard by electric shock may occasionally occur. Do not touch the G3RV's terminal (Charging part) while the power supply turned on.	
The G3RV may occasionally rupture in case of a short circuit. To protect against short-circuit accident, install a protective device, such as a quick-burning fuse or a circuit breaker or the like, on the power supply.	
Minor hazard by electric shock may occasionally occur. Do not touch the G3RV's main circuit terminals immediately after the power is turned OFF. The internal snubber circuit is charged. * 202S,SL,G3RV-A(L) Type only	
Minor hazard by burns may occasionally occur. Do not touch the G3RV or the heat sink either while the power supply is ON, or immediately after the power is turned OFF. The G3RV and the heat sink will be hot.	

Precautions for Safe Use

- Shipping
 - When shipping the G3RV, be sure to avoid the following:
 - Conditions where the G3RV is exposed to water.
 - High ambient temperatures and humidity.
 - Inadequate packaging
 - Failure to avoid these conditions while shipping G3RV will lead to damage, malfunction, or deterioration.
- Operating and Storage Locations
 - Do not use or store the G3RV in the locations listed below. Failure to do so may result in damage, malfunction, or deterioration of performance characteristics.
 - Locations subject to rain or water drops.
 - Locations subject to exposure to water, or oil, or chemicals.
 - Locations subject to high temperatures or high humidity.
 - Locations subject to ambient temperatures outside the range from -30 to +100 centigrade.
 - Locations subject to relative humidity outside the range 45% to 85%.
 - Locations subject to corrosive or flammable gases.
 - Locations subject to dust (especially iron dust) or salts.
 - Locations subject to barrier.
 - Locations subject to static electricity or other forms of noise.
 - Locations subject to strong electromagnetic fields.
 - Locations subject to possible exposure to radioactivity.

- Handling
 - Be sure to provide adequate air flow to G3RV. Failure to do so can cause the G3RV to overheat leading to short circuit and burning.
 - Do not install G3RV Relay with bent terminals into the socket. Doing so could lead to poor electrical connection and hazardous conditions.
 - Be sure to mount G3RV's with clean hands. Performing mounting with oil stained hands or coated with metal powder could result in hazardous outcomes.
- Mounting
 - Be sure to mount the G3RV in the specified orientation. Mounting the G3RV in a different orientation could lead to abnormal heat generation causing output elements to short leading to burning.
 - G3RV's are SSR's and generate heat. Be sure to control ambient temperature in setting where G3RV is used. If mounted in an enclosed space, install a fan to insure G3RV is properly ventilated.
 - Be sure that the G3RV clicks into place when mounting it to DIN Track. The G3RV may fall if it is not mounted correctly.
- Wiring
 - Use a wire an adequate size for current to be applied. Abnormal heating of wire may cause burning.
 - Do not use any wires with damaged sheaths. These may cause electric shock.
 - Confirm that wiring to G3RV Socket is not used in pipe or duct for high voltage power supply. Using a wire in pipe or duct connected to high voltage power supply will generate induction causing malfunction or damage.
 - Be sure to conduct wiring with the power supply turned OFF. Touching the terminals when they are charged may occasionally result in minor electric shock.
- Using
 - Select a load within the rated range. Inappropriate load may cause misoperation, trouble or burning.
 - Select the power supply within the rated frequency range. Inappropriate power frequency may cause misoperation, trouble or burning.

Precautions for Correct Use

- G3RV uses electronics parts inside, so that any dropping, vibration, and physical shock beyond the standard level should be prevented. Failure to do so may result in damage, malfunction, or deterioration of performance characteristics.
- Be sure to use tightening torque of 0.4 N·m for screw terminal G3RV. Failure to do so could result in short circuit failure and burning.
- Be sure to use proper voltage/current to G3RV input and output terminals. Failure to do so could result in short circuit failure and burning.

● Mounting

<SSR Mounting Pitch (Panel Mounting)>

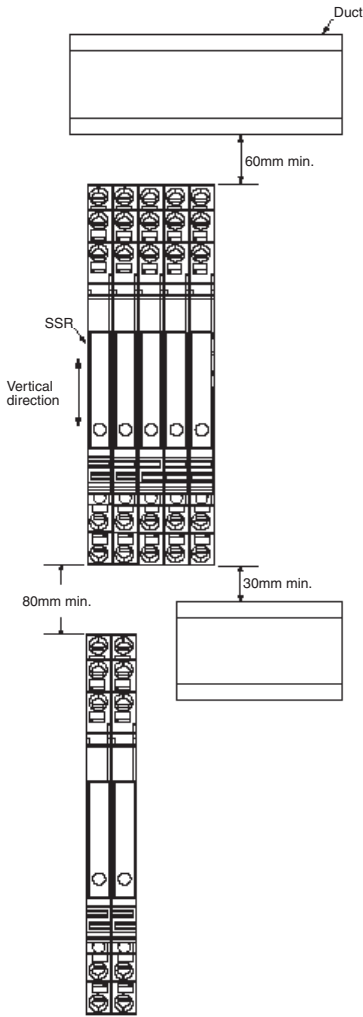

<Relations between SSR and duct (Depth of duct)>

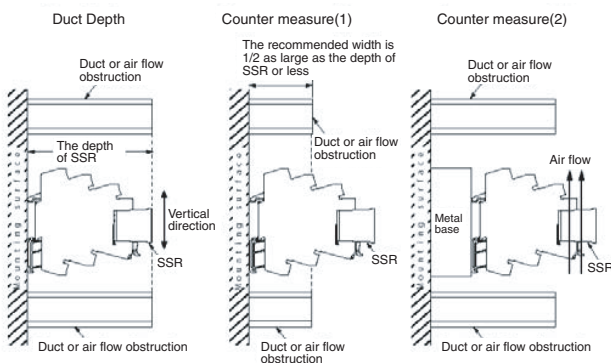

Do not surround the SSR with the duct in the depth direction, or otherwise the heat radiation of the SSR will be adversely affected.

Use a short duct in the depth direction.

If the height of the ducts can not be lowered, place the SSR or a metal base so that they are not surrounded by the ducts.

<Ventilation Outside the Control Panel>

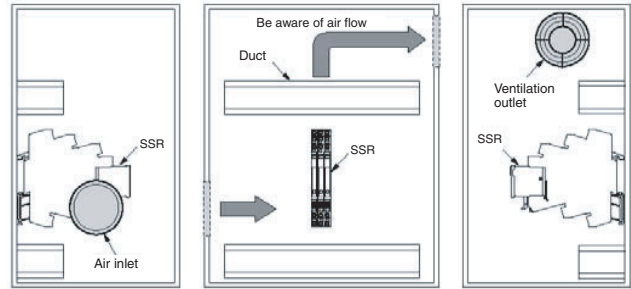

- * If the air inlet or outlet has a filter, clean the filter regularly to prevent it from clogging and ensuring efficient flow of air.
- * Do not locate any objects around the air inlet or air outlet, otherwise the objects may obstruct the proper ventilation of the control panel.
- * A heat exchanger, if used, should be located in front of the G2RVs to ensure the efficiency of the heat exchanger.
- * Please monitor the ambient temperature of the G3RV's. The rated load current is measured at 25°C ambient temperature.
- * A G3RV uses semiconductor in the output element. This causes the temperature inside the control panel to increase due to heating resulting from the passage of electrical current through the load. To restrict heating, attach a fan to the ventilation outlet or air inlet of the control panel to ventilate the panel. This will reduce the ambient temperature of the G3RVs and thus increase reliability. (Generally, each 10°C reduction in temperature will double the expected life.)

● EMI

- This is a class A product. In residential areas it may cause radio interference, in which case the user may be required to take adequate measures to reduce interference.

Suitability for Use

OMRON shall not be responsible for conformity with any standards, codes, or regulations that apply to the combination of the products in the customer's application or use of the product.

Take all necessary steps to determine the suitability of the product for the systems, machines, and equipment with which it will be used.

Know and observe all prohibitions of use applicable to this product.

NEVER USE THE PRODUCTS FOR AN APPLICATION INVOLVING SERIOUS RISK TO LIFE OR PROPERTY WITHOUT ENSURING THAT THE SYSTEM AS A WHOLE HAS BEEN DESIGNED TO ADDRESS THE RISKS, AND THAT THE OMRON PRODUCT IS PROPERLY RATED AND INSTALLED FOR THE INTENDED USE WITHIN THE OVERALL EQUIPMENT OR SYSTEM.

See also Product catalog for Warranty and Limitation of Liability.

ALL DIMENSIONS SHOWN ARE IN MILLIMETERS.
To convert millimeters into inches, multiply by 0.03937. To convert grams into ounces, multiply by 0.03527.