



High-speed Sub-micron Displacement Sensor
with 40,000 Samples/sec.

High Accuracy Inductive Gauging Technology

High-Performance & Simple Setup

High-speed, high-accuracy detection allows for 24-hour monitoring of facilities and products, preventing defective products from being produced.

The high-speed, 40,000 samples/second sampling, does not overlook any instantaneous changes. Even high-speed production lines or moving objects can be measured accurately and efficiently.

The EX-V Series significantly improves the reliability of facility monitoring system by adding more accurate measurement to the rugged design, which is virtually unaffected by harsh environments.

Bottom-dead-center measurement

High-accuracy and high-speed sampling enables the detection of minute changes in end of stroke.

Vibration measurement

The high-speed sampling of 40,000 times/second allows for reliable detection of abnormal vibrations in facilities.

Gap measurement

The rugged, compact sensor head allows for accurate measurement of the position or gap between devices.

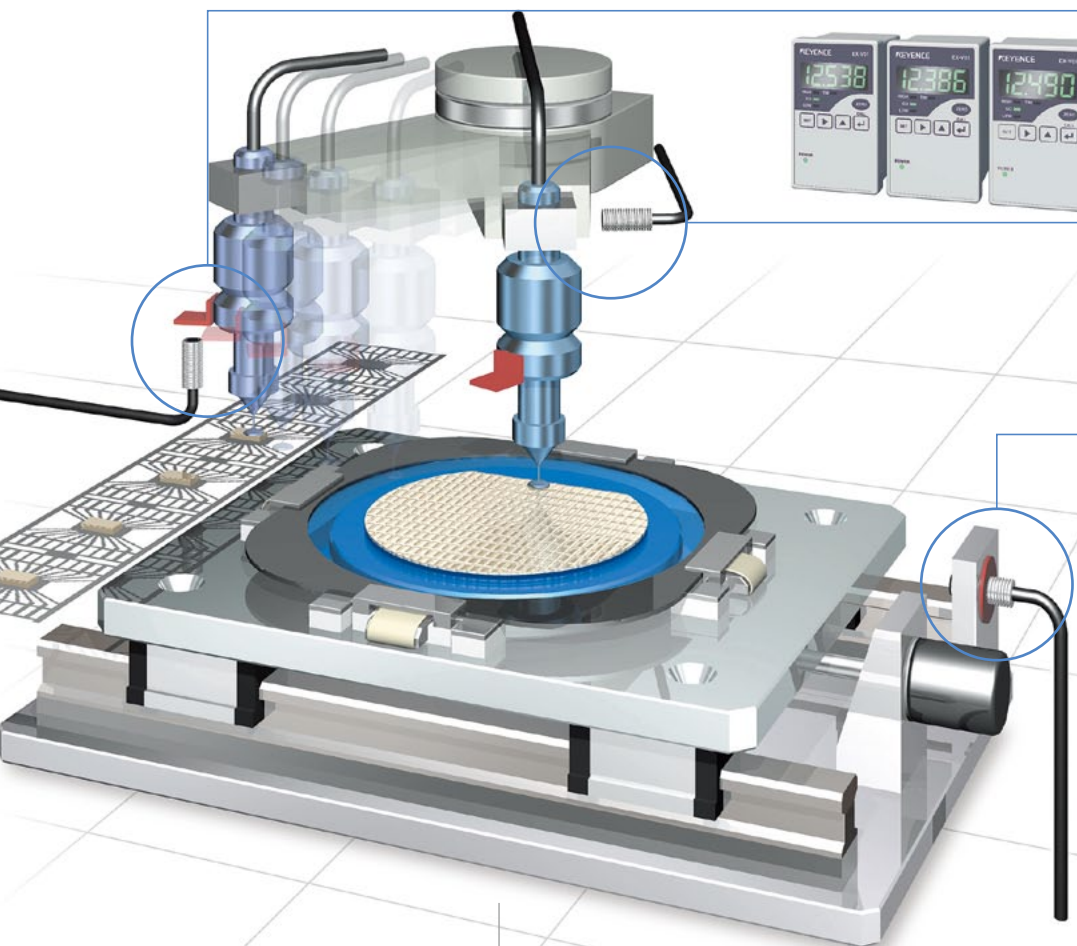

High-speed, High-Accuracy Digital Displacement Sensor

EX-V Series



Best-in-its class accuracy and high-speed sampling

The EX-V Series combines high-speed sampling with a newly developed linearity correction circuit which results in dramatic performance improvement over conventional eddy current systems.

High-speed sampling: 40,000 samples/second

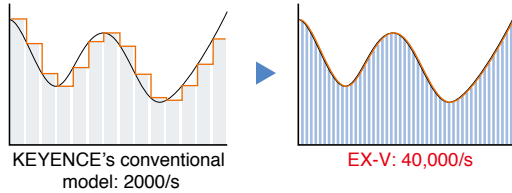

Instantaneous changes can be detected reliably.

The high-speed digital processing circuit allows for accurate detection of real peak (bottom) values that cannot be detected at conventional sampling speeds.

High resolution: 0.02% of F.S.; Linearity: $\pm 0.3\%$ of F.S.

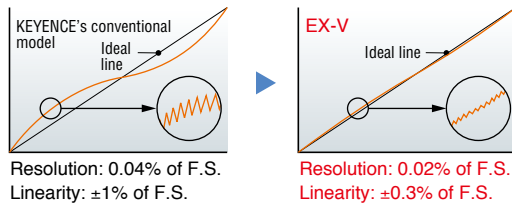

FLL circuit for high accuracy

The FLL (Flat Level Linearize) circuit applies the optimal linearization correction for each individual sensor head. You can achieve the measurement with best-in-its class accuracy with simple setting.

Significant reductions in cost/labor-hours at the touch of a button

The optimal program for the application is automatically set by just selecting the measurement mode. There is no need for complicated settings of a trigger input, timer setting or arithmetic operation using external devices.

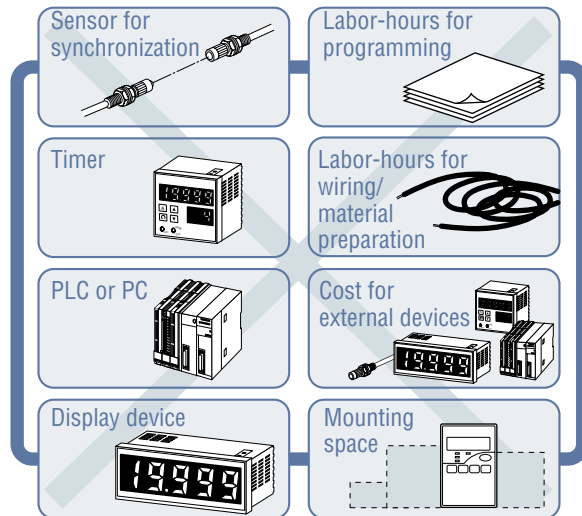

Timer operation or average value calculation can be set at the push of a button on the EX-V digital controller. No PLC or PC is necessary. No external devices are needed for synchronization.

Small and highly resistant sensor head

Considering the use in factories, the sensor head is designed to be resistant against harsh environments, to save space and to allow for easy maintenance.

Resistant against harsh environments: IP67 rated



All models are rated as IP67, offering resistance against both water and oil. They offer reliable operation even in harsh environments.

Space saving: Compact or low-profile type available

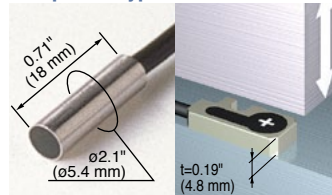

You can select the optimal sensor head according to the application and available mounting space.

Easy maintenance

Compatible sensor head

The FLL circuit allows for compatibility among sensor heads of the same model.

Alarm output

The alarm output indicates accidental breakage or disconnection of the sensor head.

Easy maintenance and useful functions ensure reliable operation in factories.

Just select the optimal setting for your application.



Basic modes for quick operation

Optimal settings for common applications are preprogrammed. Simply selecting the appropriate mode completes the setting. There is no need for time-consuming initial setting or adjustment.

Select the mode



For automatic setting

Bottom-dead-center mode

Eccentricity/vibration mode

Thickness/gap mode



Bottom-dead-center mode

Bottom-dead-center hold

Automatic trigger

Previous value comparison

Automatically detects the bottom dead center of stroke.

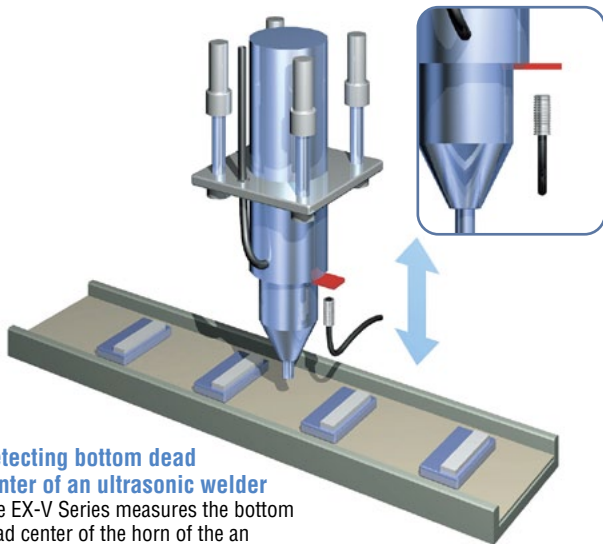

Detecting bottom dead center of an ultrasonic welder

The EX-V Series measures the bottom dead center of the horn of the an ultrasonic welder to detect defective welding.

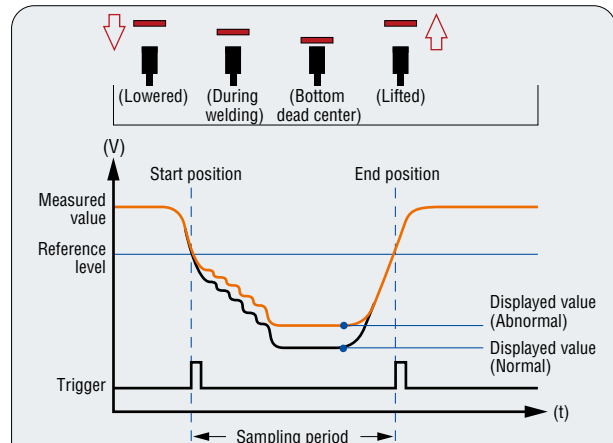

Just selecting the bottom-dead-center mode automatically activates trigger inputs. The position of the bottom dead center within the sampling period is detected and then judged whether it is within the tolerance range or not.



Eccentricity/vibration mode

Amplitude hold

Automatic trigger

Cyclical difference measurement

Accurately measures amplitude without being affected by changes over time.

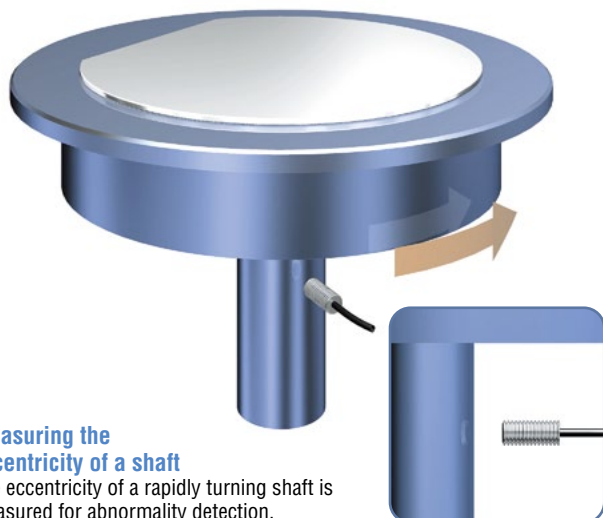

Measuring the eccentricity of a shaft

The eccentricity of a rapidly turning shaft is measured for abnormality detection.

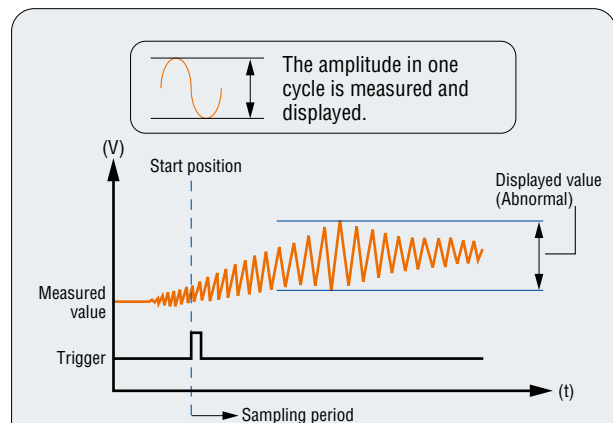

Measurement automatically starts when the amplitude exceeds the specified value. If the amplitude exceeds the tolerance range, an output is produced to indicate abnormal vibration.



Thickness/gap mode

Continuous

Average

Internal timer

Measures the average thickness of the desired section with a simple setting.

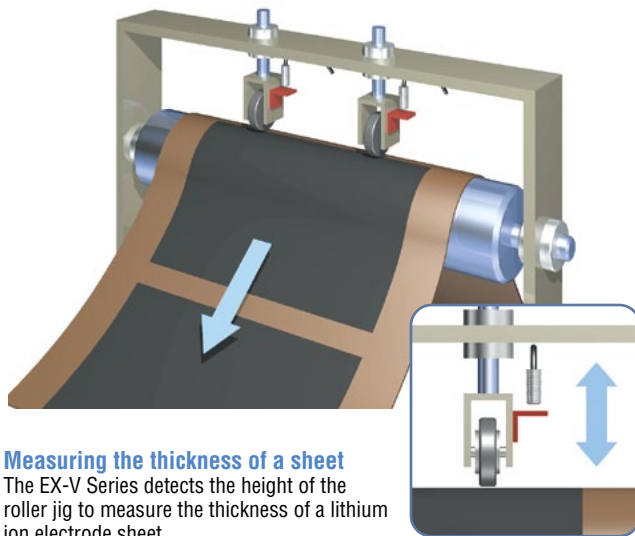

Measuring the thickness of a sheet
The EX-V Series detects the height of the roller jig to measure the thickness of a lithium ion electrode sheet.

Average measurement

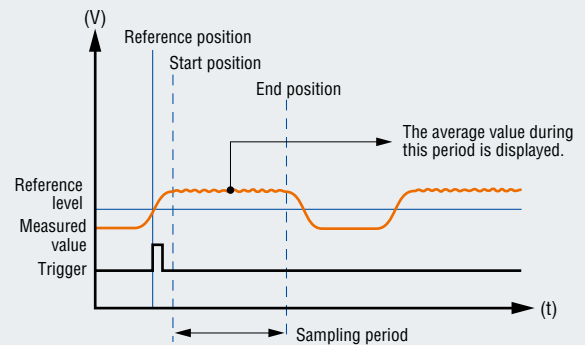

Just selecting the "Average" measurement type automatically activates trigger inputs to measure the average value within the specified section.

Select the program best suited for your application.

Various measurement modes

You can select the measurement mode best suited for your application, such as the limited bottom-dead-center mode or difference between peaks (bottoms) mode.

Limited bottom-dead-center mode

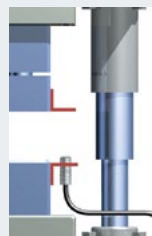

Detecting swarf generation in a press

The swarf may not be detected at the bottom dead center of the die because it is crushed there. Detecting the bottom dead center of the stripper allows for stable detection.

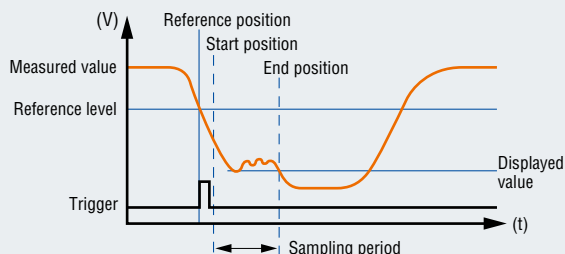
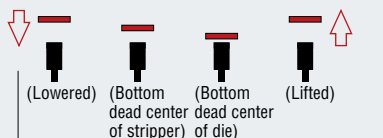

Automatic trigger

When a target approaches the sensor, a trigger signal is automatically turned ON to start measurement. There is no need for an external trigger input or timer setting.

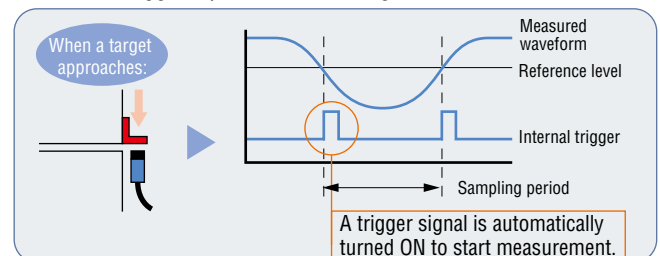

Timer function

The flicker function using the internal timer allows for measurement of the average value or vibration within a specified period. Moreover, the timer enables adjustment of the start or end point of measurement from the instant the automatic trigger is turned ON.

Previous value comparison

The latest measured value can be compared with the average value of the previous measurements. This allows for the detection of only abrupt changes without being affected by changes over time.

Various Functions for Every Need

Measurement period output

The measurement period for bottom-dead-center or eccentricity detection can be specified by strobe outputs. By connecting the EX-V Series to an oscilloscope or other device, you can adjust the device while monitoring a waveform.







Comparator output disable input

The comparator output can be stopped with external signals. While continuing comparator operation, you can stop the output until the device operation stabilizes.

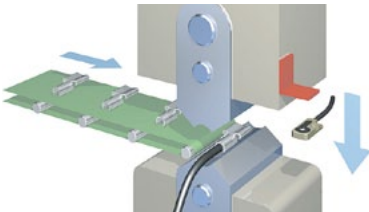
Tolerance limit memory function

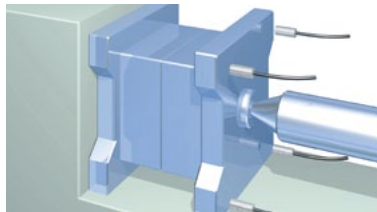
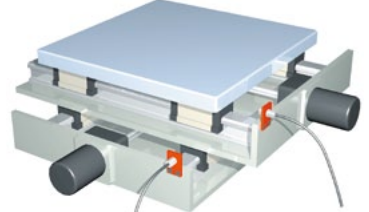
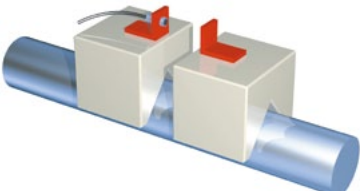
Up to four upper/lower tolerance limit settings can be stored in memory. You can switch these settings also by external signals. This makes changeover quick and easy.

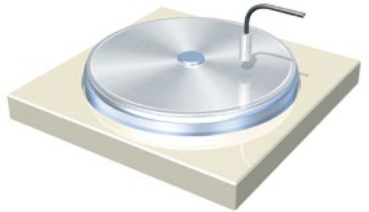
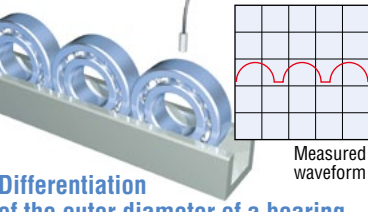
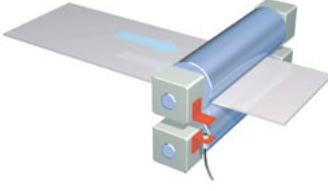
Applications by Facility/Product

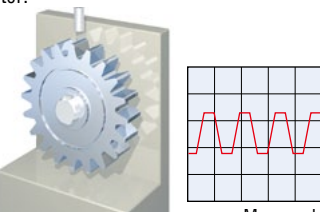
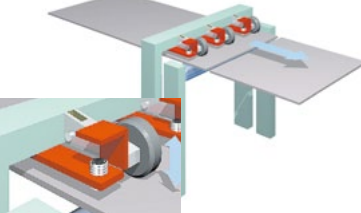
	Electric machinery/ electronics	Metal/automobile	Plastic/paper
Facility	 <p>Detecting improper crimping Improper crimping can be detected by checking the bottom dead center of the machine.</p>	 <p>Measuring the eccentricity of ATC tools Eccentricity due to trapped swarf can be detected.</p>	 <p>Measuring the distortion of a die for an injection molding machine The amount of distortion can be measured by comparing the measured values before and after the load is applied.</p>
	 <p>Checking the origin of the X-Y stage The resolution of 0.4 μm enables accurate measurement of the position of the origin.</p>	 <p>Measuring the elongation of a tie bar The elongation of the tie bar of a die-cast machine can be measured by using a magnet jig.</p>	 <p>Detecting the surface runout of a slit blade The eccentricity mode automatically detects the surface runout exceeding the reference value.</p>
Product	 <p>Measuring the surface runout of a disk The eccentricity mode detects the surface runout of a disk.</p>	 <p>Differentiation of the outer diameter of a bearing The bottom-dead-center mode detects the point where the bearing comes the closest to the sensor head to differentiate the outer diameter.</p>	 <p>Measuring the gap between rollers The gap between the molding rollers can be accurately measured</p>
	 <p>Measuring subtle vibration of a precision motor Detecting abnormal vibration prevents defective products from being sent to the next process.</p>	 <p>Detecting the eccentricity of a gear Setting the eccentricity mode to the difference between peaks measurement type detects the eccentricity in gear teeth tops.</p>	 <p>Detecting double-fed paper bags Detecting the movement of a jig allows for differentiation between one and two paper bags.</p>





Selection Chart

Controller



EX-V Series

Sensor head

Shape	Measuring range	Resolution	Model
 $\phi 5.4 \times 18 \text{ mm}$ $\phi 0.21" \times 0.71"$	1 mm 0.04"	0.4 μm	EX-305V
 M10 x 18 mm 0.71"	2 mm 0.08"	0.4 μm	EX-110V
 $\phi 14.5 \times 20 \text{ mm}$ $\phi 0.57" \times 0.79"$	5 mm 0.20"	1 μm	EX-416V
 $\phi 22 \times 35 \text{ mm}$ $\phi 0.87" \times 1.38"$	10 mm 0.39"	2 μm	EX-422V
 14 x 30 x 4.8 mm $0.55" \times 1.18" \times 0.19"$	4 mm 0.16"	1 μm	EX-614V

Specifications

Shape		Cylindrical	Threaded	Cylindrical + threaded		Thin profile
		$\phi 5.4 \times 18 \text{ mm}$ $\phi 0.21" \times 0.71"$	M10 x 18 mm 0.71"	$\phi 14.5 \times 20 \text{ mm}$ $\phi 0.57" \times 0.79"$	$\phi 22 \times 35 \text{ mm}$ $\phi 0.87" \times 1.38"$	14x30x4.8 mm $0.55" \times 1.18" \times 1.19"$
Model	Sensor head	EX-305V	EX-110V	EX-416V	EX-422V	EX-614V
	Controller	NPN EX-V01 PNP EX-V01P	EX-V02 EX-V02P	EX-V05 EX-V05P	EX-V10 EX-V10P	EX-V64 EX-V64P
Measuring range		0 to 1 mm 0.04"	0 to 2 mm 0.08"	0 to 5 mm 0.20"	0 to 10 mm 0.39"	0 to 4 mm 0.16"
Display range		-19999 to +19999				
Linearity		$\pm 0.3\%$ of F.S.				
Resolution		0.4 μm	0.4 μm	1 μm	2 μm	1 μm
Sampling rate		40000 samples max./sec. ¹				
Display rate		20/sec.				
Display character		7-segment 2-color LED				
Range-over alarm		$\pm \text{FFFF}$ is displayed.				
Control input	Timing input	NPN: Open-collector or non-voltage contact PNP: Applied voltage; 10 to 30 V				
	Reset input					
	Auto-zero input					
	Comparator output disable input					
	Synchronous input					
	External setting input					
Control output	Tolerance setting	Upper/lower 2-level setting x 4 sets (selectable)				
	Signal	NPN open-collector (HIGH, GO and LOW): 100 mA max. (40 V max.) PNP open-collector (HIGH, GO and LOW): 100 mA max. (30 V max.)				
	Response time	0.075 ms (at maximum speed)				
	Off-delay time	60 ms				
Strobe output		NPN open-collector: 100 mA max. (40 V max.) (N.O.) PNP open-collector: 100 mA max. (30 V max.) (N.O.)				
Alarm output		NPN open-collector: 100 mA max. (40 V max.) (N.C.) PNP open-collector: 100 mA max. (30 V max.) (N.C.)				
Analog voltage output	Output voltage	$\pm 5 \text{ V}$				
	Impedance	100 Ω				
	Response time	0.075 ms (at maximum speed)				
Temperature fluctuation		0.07% of F.S./ $^{\circ}\text{C}$ ²				
Power supply		24 VDC $\pm 10\%$, Ripple (P-P): 10% max.				
Current consumption		240 mA max.				
Ambient temperature	Sensor head	-10 to +60 $^{\circ}\text{C}$ (14 to 140 $^{\circ}\text{F}$), No freezing				
	Controller	0 to +50 $^{\circ}\text{C}$ (32 to 122 $^{\circ}\text{F}$), No freezing				
Relative humidity		35 to 85%, No condensation				
Vibration		10 to 55 Hz, 1.5 mm 0.06" double amplitude in X, Y and Z directions, 2 hours respectively				
Weight	Sensor head (including 3-m cable)	Approx. 45 g	Approx. 55 g	Approx. 75 g	Approx. 200 g	Approx. 60 g
	Controller	Approx. 235 g				
Major functions		Auto-zero function, Offset function, Measurement modes (15 types), Tolerance limit value memory function (4 patterns)				

The above data was obtained using an iron target (S45C, SS400, $t = 1 \text{ mm } 0.04"$). When measuring aluminum, copper, or stainless steel targets, refer to the linear characteristics for these materials.

1. When the digital filter function is used, the sampling rate is 20000 sampling/sec.

2. When the distance between the sensor head and the target is within 50% of the measuring range.

Dimensions

Controller **EX-V01(P)/EX-V02(P)/EX-V05(P)/EX-V10(P)/EX-V64(P)**

Panel cutout

Unit: mm *Inch*

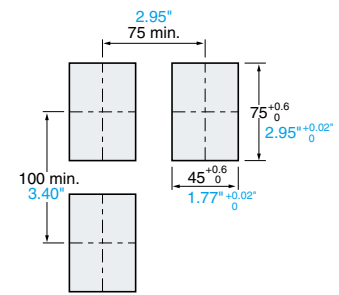
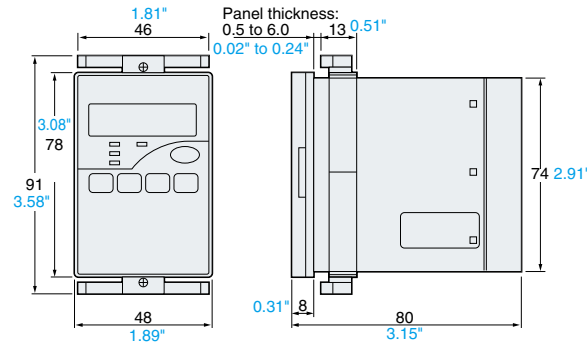

Sensor head

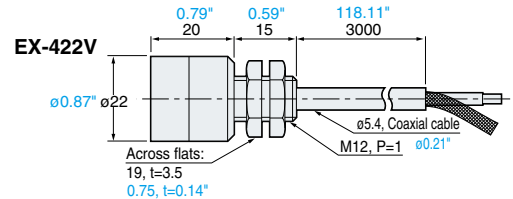
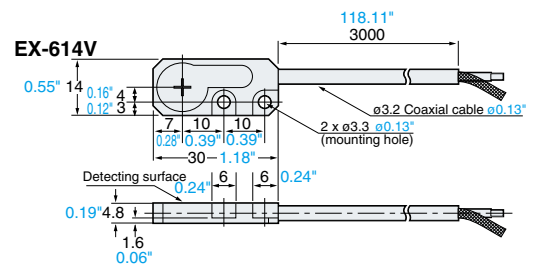
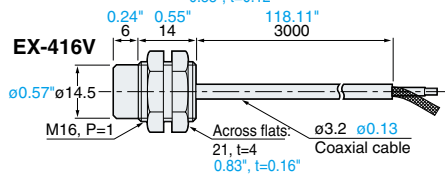
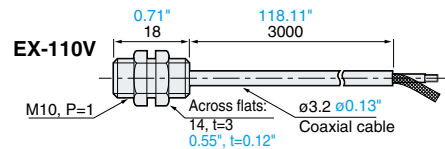
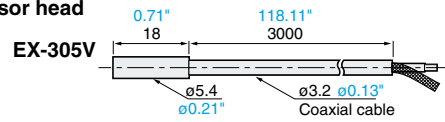

Options



OP-35407 Mounting stand

The stand has two 0.63" (16-mm) diameter mounting holes for attaching a push-button switch for reset input or comparator output disable input.

* The switch is not included. Contact KEYENCE for details.

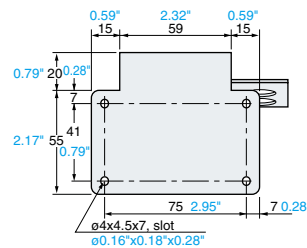

CALL TOLL FREE TO CONTACT YOUR LOCAL OFFICE
1-888-KEYENCE
1-888-539-3623

www.keyence.com



SAFETY INFORMATION

Please read the instruction manual carefully in order to safely operate any KEYENCE product.

CONTACT YOUR NEAREST OFFICE FOR RELEASE STATUS

KEYENCE CORPORATION OF AMERICA

Head Office 500 Park Boulevard, Suite 200, Itasca, IL 60143, U.S.A.

PHONE: +1-201-930-0100

FAX: +1-855-539-0123

E-mail: keyence@keyence.com

AL Birmingham	CA San Jose	CO Denver	IL Chicago	MI Detroit	MO St. Louis	NC Raleigh	PA Philadelphia	TN Nashville	WI Milwaukee
AR Little Rock	CA Cupertino	FL Tampa	IN Indianapolis	MI Grand Rapids	NJ Elmwood Park	OH Cincinnati	PA Pittsburgh	TX Austin	
AZ Phoenix	CA Los Angeles	GA Atlanta	KY Louisville	MN Minneapolis	NY Rochester	OH Cleveland	SC Greenville	TX Dallas	
CA San Francisco	CA Irvine	IA Iowa	MA Boston	MO Kansas City	NC Charlotte	OR Portland	TN Knoxville	WA Seattle	

KEYENCE CANADA INC.

Head Office PHONE: +1-905-366-7655 FAX: +1-905-366-1122 E-mail: keyencecanada@keyence.com

Montreal PHONE: +1-514-694-4740 FAX: +1-514-694-3206 Windsor PHONE: +1-905-366-7655 FAX: +1-905-366-1122

KEYENCE MEXICO S.A. DE C.V.

PHONE: +52-55-8850-0100 FAX: +52-81-8220-9097

E-mail: keyencemexico@keyence.com

The information in this publication is based on KEYENCE's internal research/evaluation at the time of release and is subject to change without notice. Company and product names mentioned in this catalog are either trademarks or registered trademarks of their respective companies. The specifications are expressed in metric units. The English units have been converted from the original metric units. Copyright (c) 2000 KEYENCE CORPORATION. All rights reserved.